

Ville ^{AV47}

Anderssen & Voll

2025



Ville ^{AV47}

Anderssen & Voll

2025

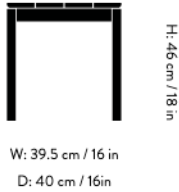

Product description

Outdoor footstool

Environment

Outdoor

Material

Teak and powder-coated steel.

Production process

The metal frame is cut, shaped, welded being powder-coated. The webbing of the footstool is webbed by hand and cut into shape with a hot knife to avoid fraying..

Dimensions

W: 39.5 cm / 16 in
H: 46 cm / 18 in
D: 40 cm / 16 in

Weight

5.8 kg

Strength, durability and safety testing

EN 16139 Level 2 - Seating

Certifications



FSC® 100%

Gliders

Plastic gliders

Stacking quantity

5

Impact

- Made with untreated teak, a natural, renewable material, resistant against weather conditions and ageing gracefully.
- Uses FSC® certified wood, supporting responsible management of the world's forests.
- Framed in steel, a robust material, resistant against corrosion.
- Steel is highly recyclable and can be repurposed in another production cycle, reducing the demand for new material.
- Designed for disassembly, making it easier to repair, renovate, pass on, and responsibly recycle at end of life.

Manufacturer

Produced in PRC by Nine United Limited

Cleaning Instructions

Please see our [Maintenance & Care instructions here](#)

→ Stock items

Warm black, Bronze green

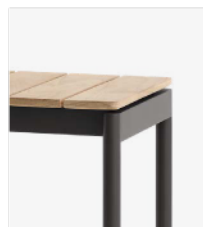

→ Warm Black

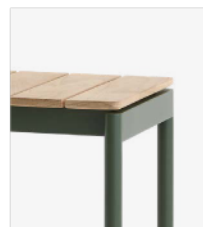

→ Bronze Green

Ville AV47

Anderssen & Voll 2025

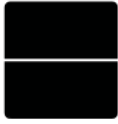

H: 2 cm / 0.8 in

W: 59 cm / 23 in

D: 29 cm / 11 in

Product description

Outdoor footstool seat pad

Environment

Outdoor

Material

Water repellent and stain proof canvas made from 50% recycled acrylic, 47% acrylic, 3% polyester.

Production process

Fast drying foam and wadding is cut to size, then put into the textile cover.

Dimensions

W: 59 cm / 23 in

H: 2 cm / 0.8 in

D: 29 cm / 11 in

Weight

0.2 kg

Gliders

Plastic gliders

Impact

- Made with 50% repurposed fibres sourced from production offcuts.
- Resistant against water, stains, UV damage and mould, prolonging its lifespan.
- Removable cover.

Manufacturer

Produced in PRC by Nine United Limited

Cleaning Instructions

[Please see our Maintenance & Care instructions here](#)

→ Stock items

Heritage Papyrus, Heritage Char

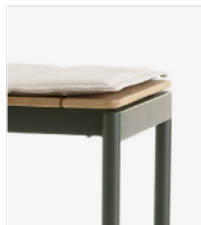

→ Heritage Papyrus

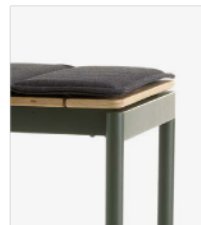

→ Heritage Char

&Tradition®

Recycling & Disassembly

Ville ^{AV47}

RECYLING

The Ville stool is built to last, and we hope that your Ville will serve you for many years. The top part is made from solid wood slats and can be easily separated from its base.

All metal and wooden parts can be separated and delivered to a suitable recycling station.

SPARE PARTS

To purchase spare parts for your Ville stool, please write to our sales support team at info@andtradition.com with your query.

5 YEAR WARRANTY

&Tradition provides a 5-year warranty with every Ville stool, which covers faults which were present at the time of purchase, or which have occurred as a result of a manufacturing defect. The warranty is valid from the date stated on the original invoice.

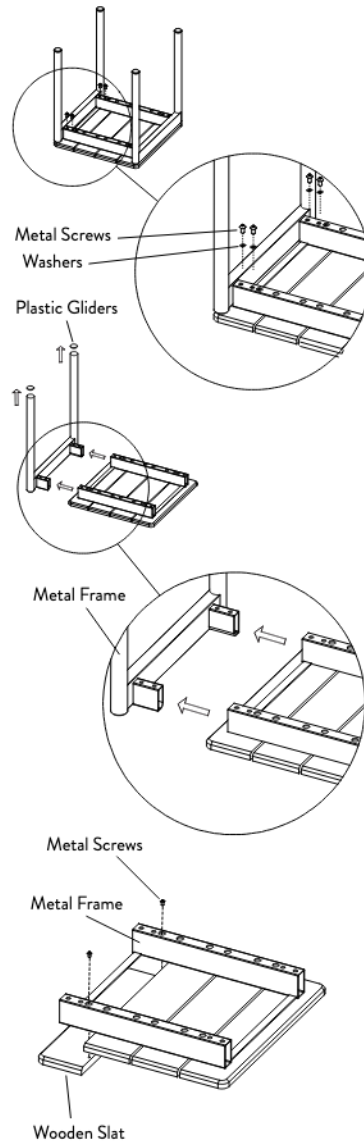

DISASSEMBLY

1. Place the stool upside down on a soft, flat surface. Using an Allen key, remove the screws connecting the legs with the frame by turning counterclockwise to loosen them. Once loosened, remove both the screws and washers from the corresponding holes.

2. Remove the legs from the frame. If you encounter any resistance, ensure all screws from the previous step have been removed. Detach the plastic gliders from the legs.

3. Remove the wooden slats from the metal frame by detaching the screws holding them in place.