

- INSTRUCTION MANUAL -

# CPH DEUX 215

L75 / 140 / 200 X W35 X H45 CM

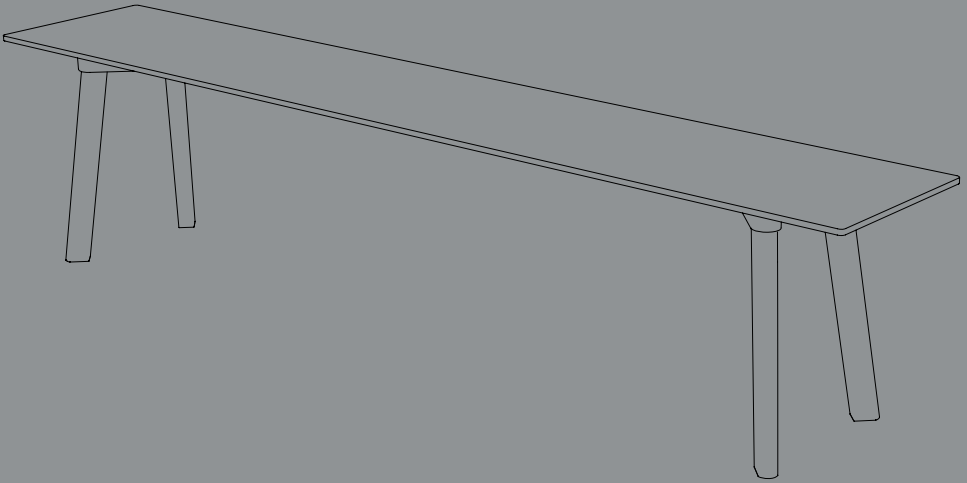

DESIGN BY RONAN & ERWAN BOUROULLEC

# HAY



L75 X W35 X H45 CM

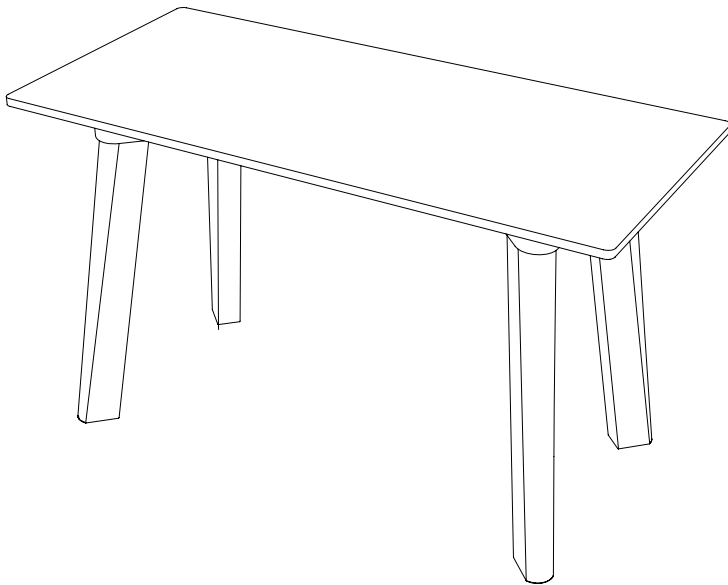

- PARTS -

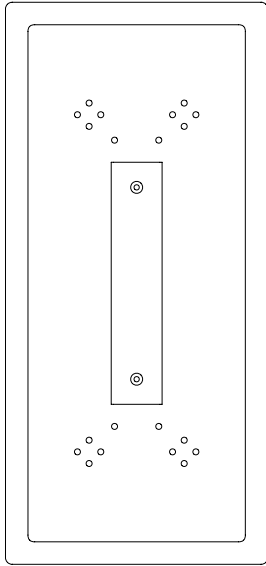

**A** Tabletop x1

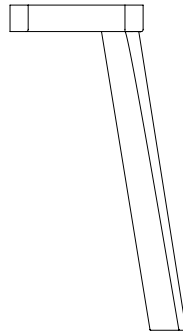

**B** Leg x4

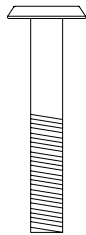

**C** Screw x20



**D** Allen key x1

Protect the table top from scratches and other damage while assembling.

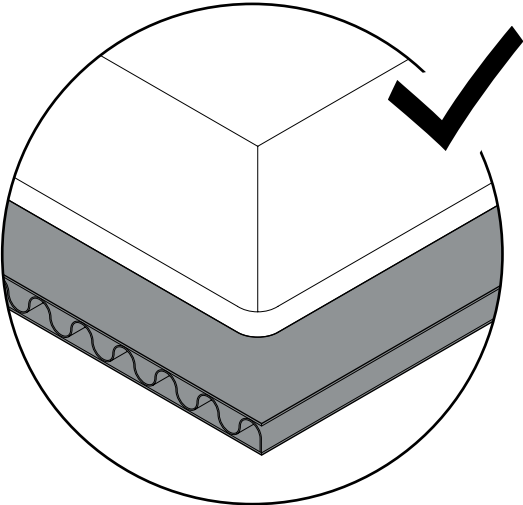
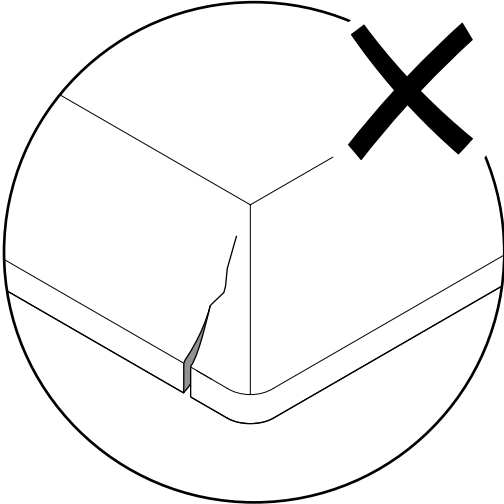

1.

Place the **B** parts on the reverse side of **A** and align them with the holes.

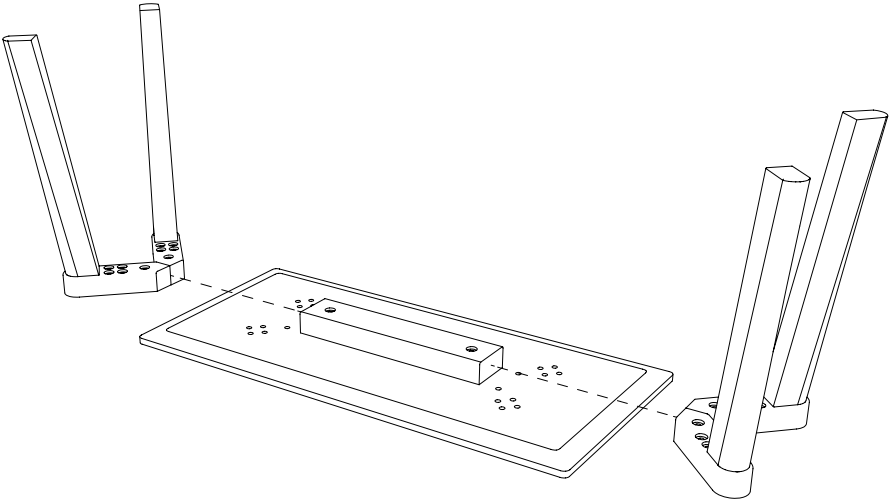

2.

Insert the **C** parts into the holes and gently tighten them.  
Use the allen key to tighten the **C** parts completely.

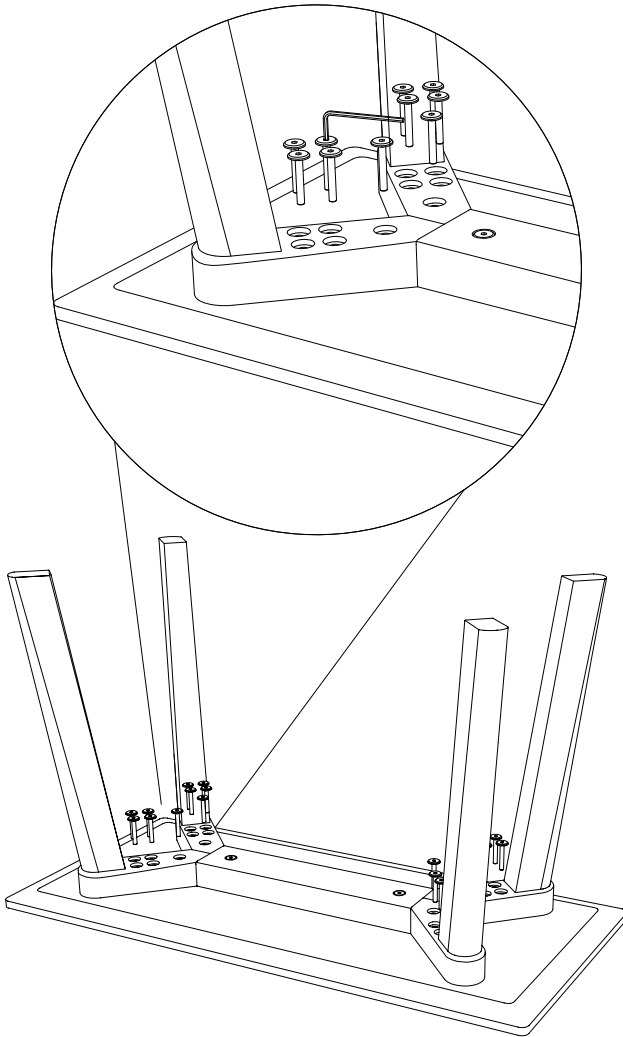

3.

Turn the bench over. Use the allen key to tighten the **C** parts completely.

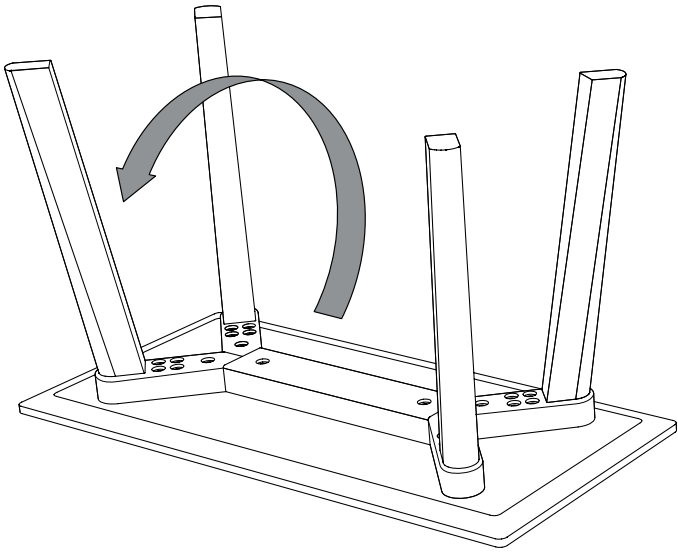



4.

Done!



- INSTRUCTION MANUAL -

L140 / 200 X W35 X H45 CM

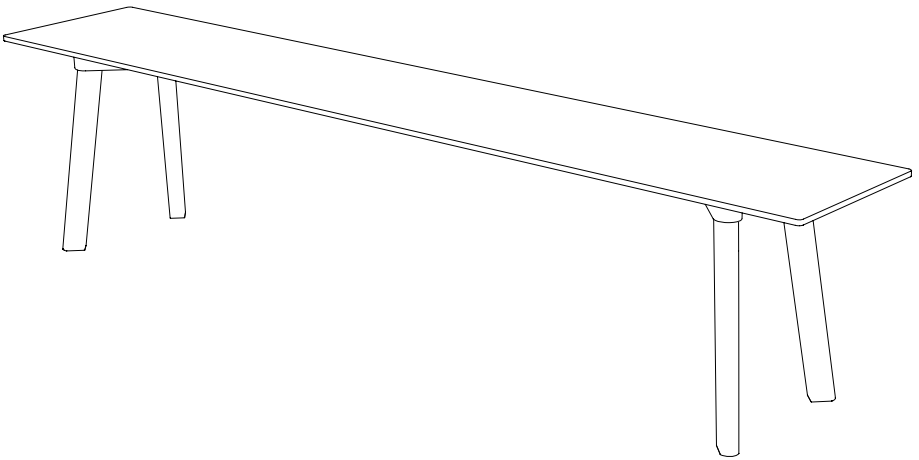

- PARTS -

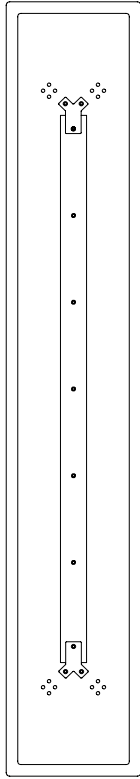

**A** Benchtop x1

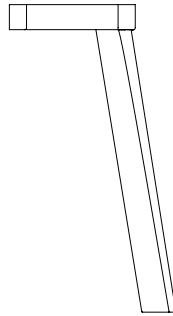

**B** Leg x4

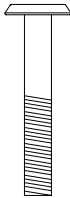

**C** Screw x16

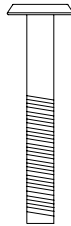

**D** Screw x4



**E** Allen key x1

Protect the table top from scratches and other damage while assembling.

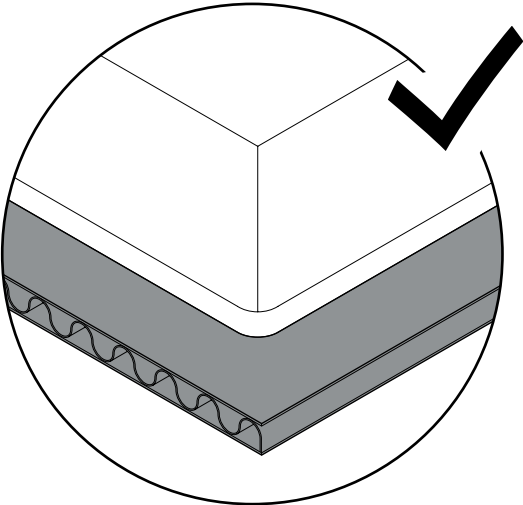
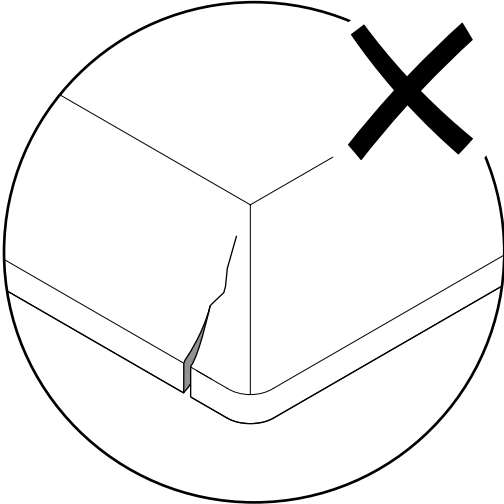

1.

Unscrew the 4 premounted **D** parts.

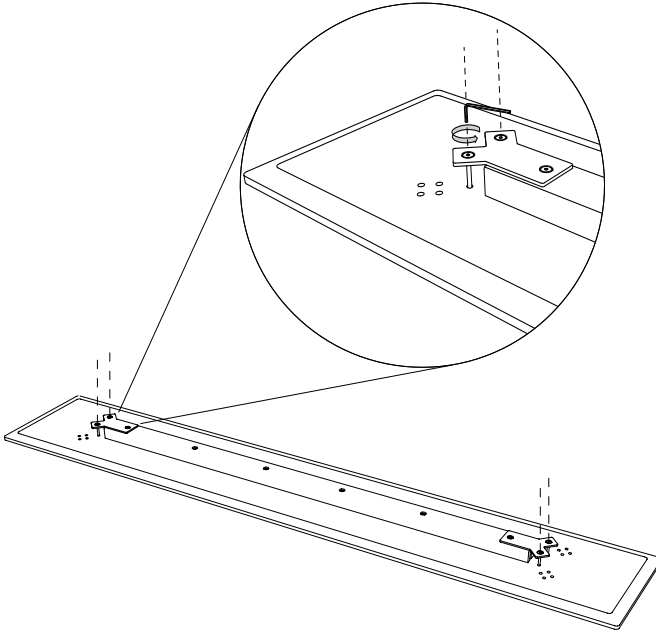

2.

Place the **B** parts on the reverse side of **A** and align them with the holes.

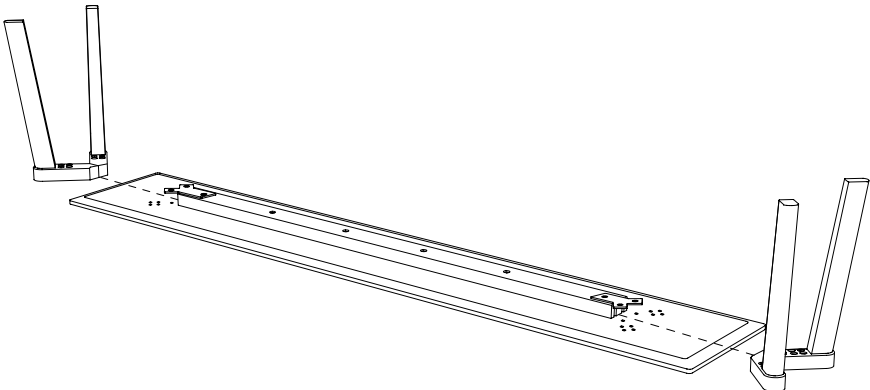

3.

Place the **D** parts again and gently tighten them.

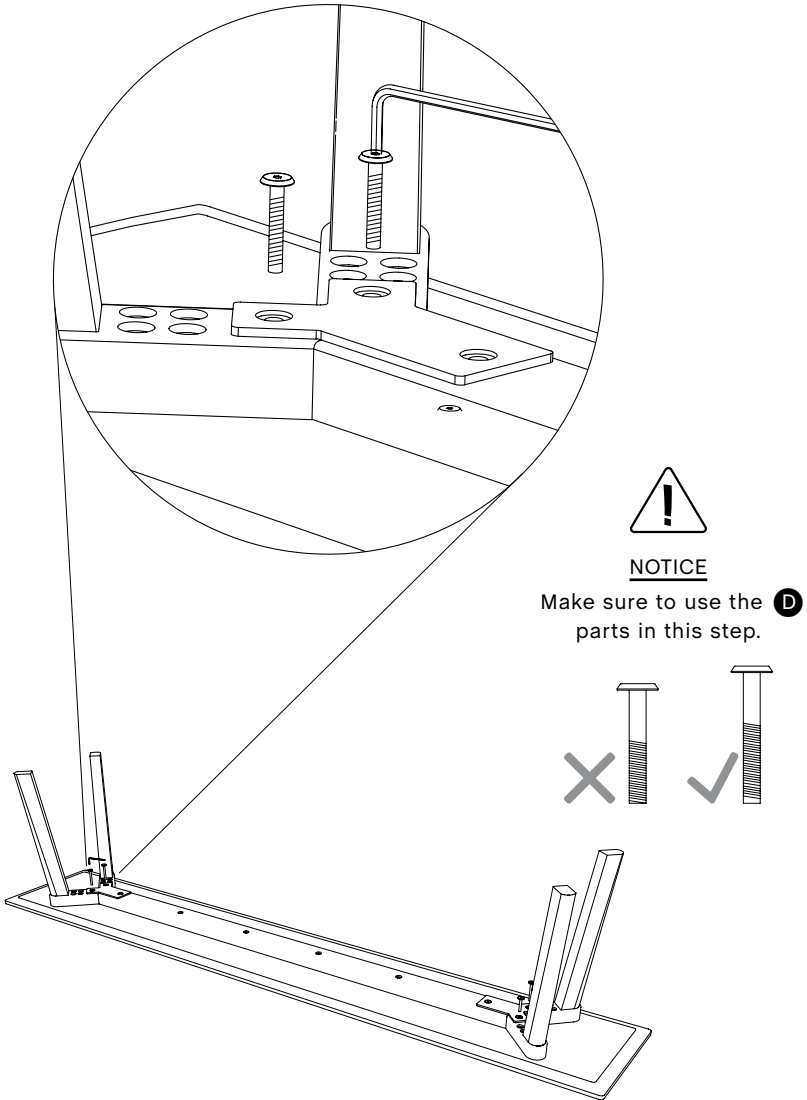

4.

Place the **C** parts and tighten gently. Use the allen key to tighten both **C** and **D** parts completely.

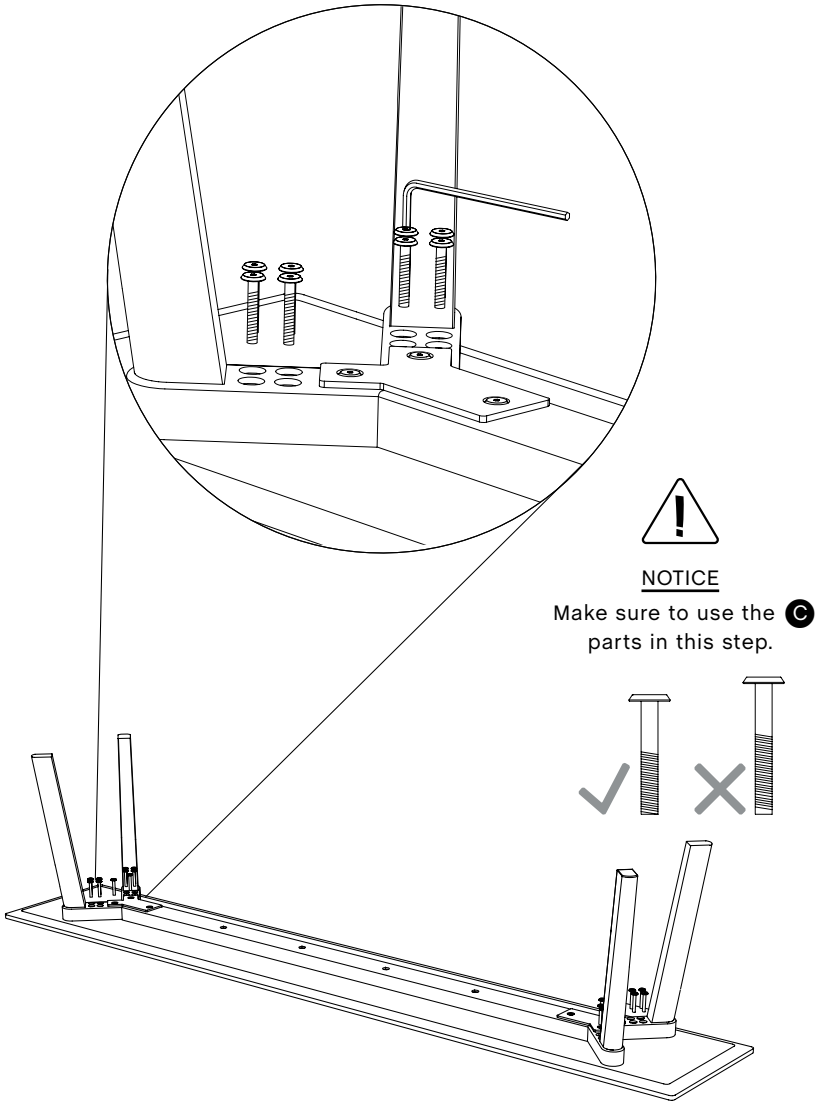

5.

Turn the bench over.

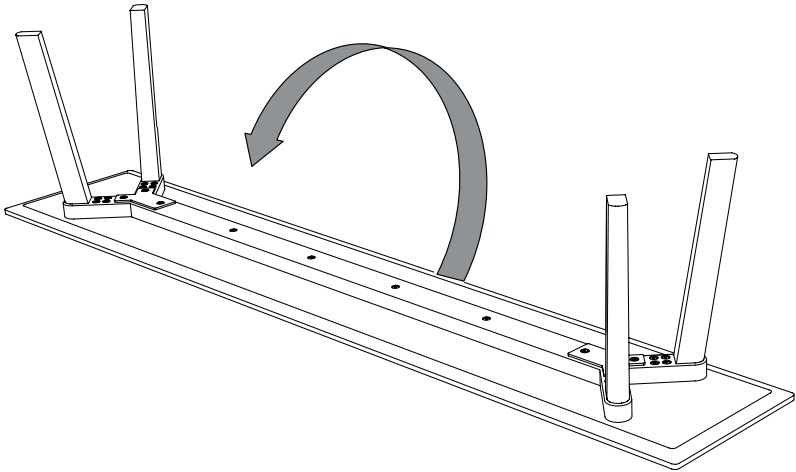

6.

Done!

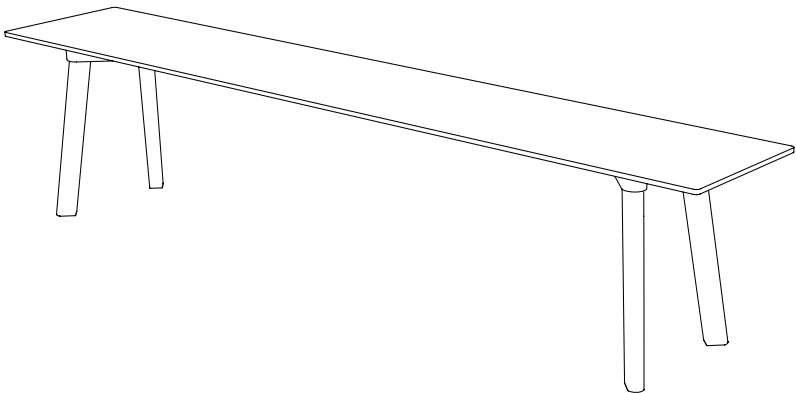



- CARE & MAINTENANCE -

Our Care & Maintenance offers guidance for optimal maintenance of your HAY product. It includes advice and instructions on cleaning and caring for specific materials to prolong the life of your furniture.



Please find our Care & Maintenance guide by scanning the QR code



You can find more relevant information on CPH Deux 215 by scanning the QR code

You can also find the same information here  
[hay.dk/downloads](http://hay.dk/downloads)

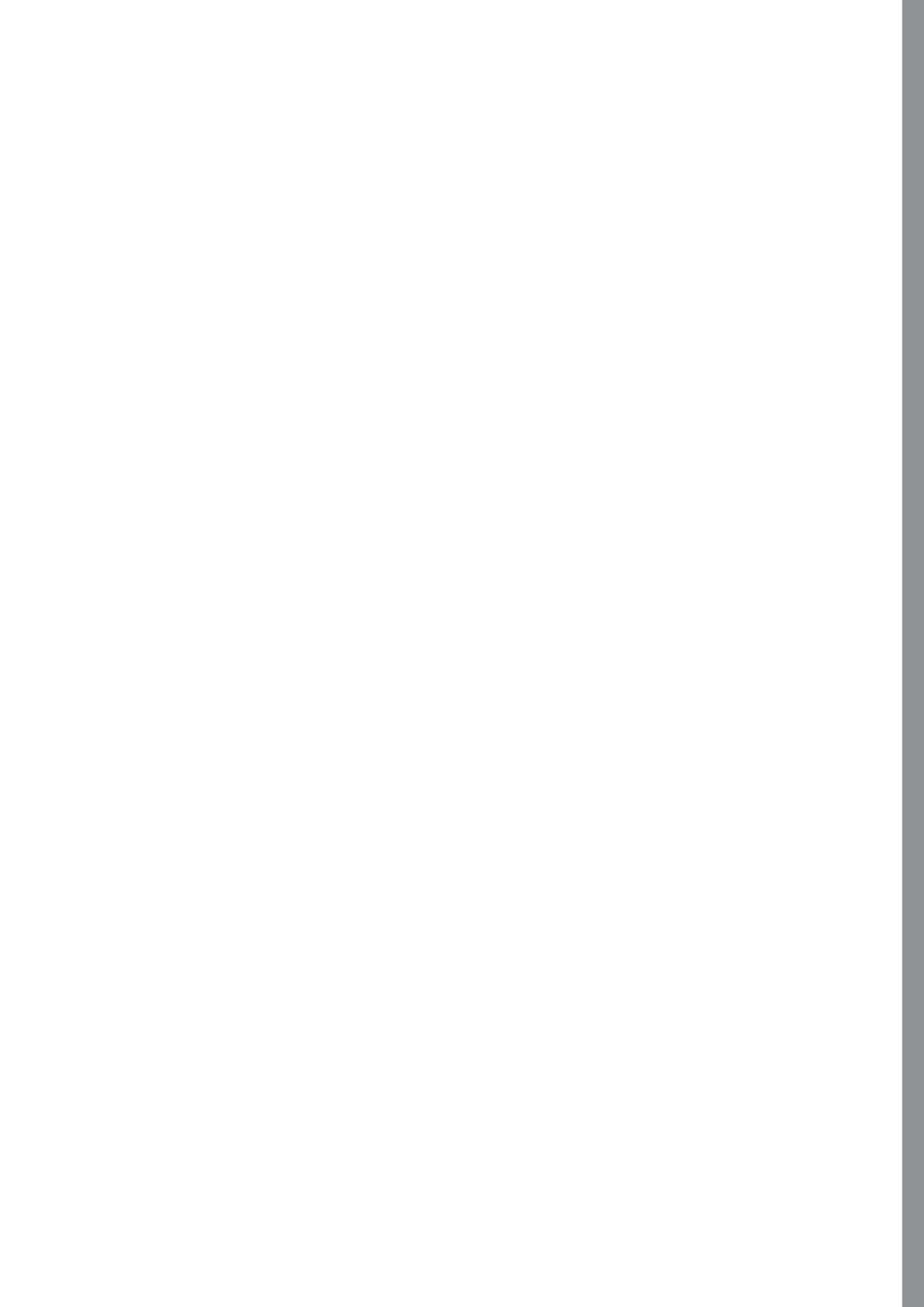



Havnen 1 8700 Horsens Denmark  
+45 3164 6000 / hay@hay.com

10/01/2023

**HAY**