

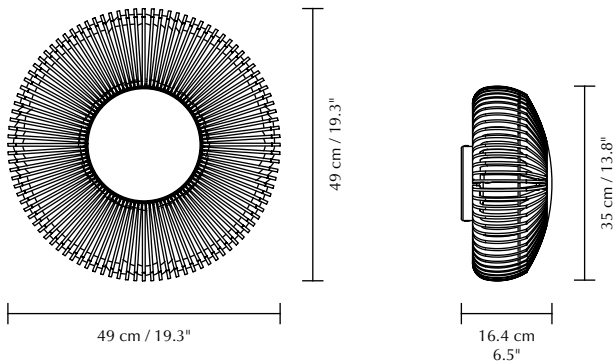



CLAVA UP WOOD

Designed by Søren Ravn Christensen





 Surface mounted lamp
Compatible with E26 / E27

DIMENSIONS
 Ø: 49 cm / 19.3" Ø: 35 cm / 13.8"
H: 16.6 cm / 6.5" H: 16.6 cm / 6.5"

 **MARKINGS, TESTS & CERTIFICATIONS**
CE, UKCA (for indoor use), IP2X

 **MATERIAL**
Oak, ash and laminated veneer

 **WEIGHT**
Clava Up Wood large: 2.2 kg / 4.9 lb
Clava Up Wood medium: 1.4 kg / 3.1 lb

 **WEIGHT INCL. PACKAGING**
Clava Up Wood large: 4.1 kg / 9 lb
Clava Up Wood medium: 2.4 kg / 5.3 lb

 **LIGHT SOURCE**
E26 / E27 - max 15W LED G40 (not included)

 **PACKAGING DIMENSIONS (L x W x H)**
Large: 53.4 x 53.4 x 19 cm / 21 x 21 x 7.5"
Medium: 40.4 x 40.4 x 18.8 cm / 15.9 x 15.9 x 7.4"

 **ASSEMBLY TIME**
5 min

 **MEDIA KIT**
Photos and press material
Download at umage.presscloud.com

ORDERING INFORMATION

Clava Up Wood large oak	#2358
Clava Up Wood large dark oak	#2359
Clava Up Wood large black oak	#2369
Clava Up Wood medium oak	#2381
Clava Up Wood medium dark oak	#2382
Clava Up Wood medium black oak	#2383

Colour variations



oak



dark oak



black oak

RECOMMENDED LIGHT SOURCE(S)
Ping Pong Idea

#4171

UMAGE

CLAVA UP WOOD

Designed by Søren Ravn Christensen



SPRUCE UP THE WALLS WITH RAYS OF LIGHT

UMAGE is extending the sculptural Clava collection with a new variant for the wall, called Clava Up wood. The recognizable shape made from laser-cut wood lamellae is designed to illuminate home with a playful flash of light on the walls in the surrounding space.

Clava Up wood is available in oak, dark oak and black oak in two different sizes.

The wall lamp will become the perfect add-on to a beautiful gallery wall or hanging side by side in a long hallway.

Find more info on our website umage.com

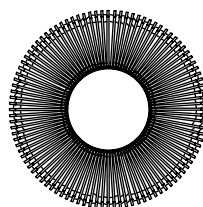

49 cm / 19.3"

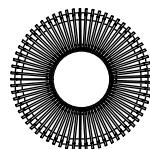

35 cm / 13.8"



168 cm / 5'5"

