

normann

C O P E N H A G E N

Norm 06 Small

SAMLEINSTRUKTION
MONTERINGSINSTRUKTIONER
MONTERINGSINSTRUKSJONER
ASSEMBLY INSTRUCTIONS
MONTAGEANLEITUNG
INSTRUCTIONS D'ASSEMBLAGE
INSTRUCCIONES DE MONTAJE
ISTRUZIONI DI MONTAGGIO
MONTAGE-INSTRUCTIES
INSTRUÇÕES DE MONTAGEM
組み立て方
조립 안내

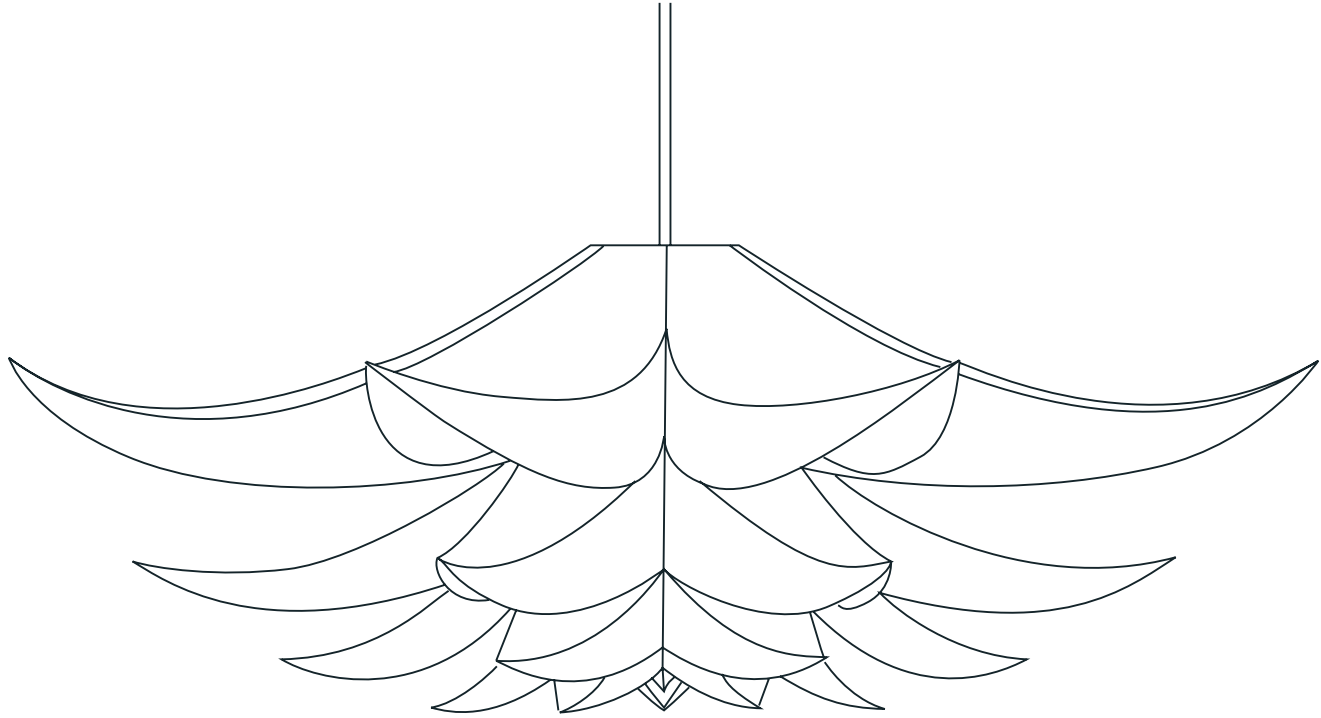

Norm 06 Small

Indhold:

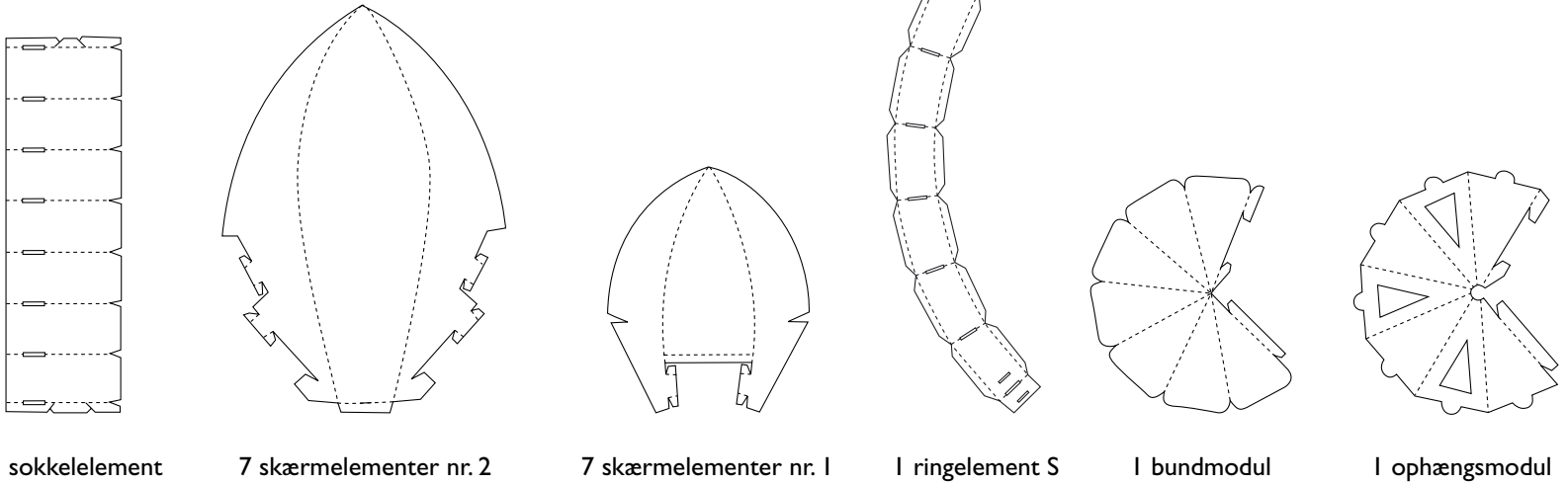

1 sokkelement

7 skærmelementer nr. 2

7 skærmelementer nr. 1

1 ringelement S

1 bundmodul

1 ophængsmodul

Samleinstruktion:

1.

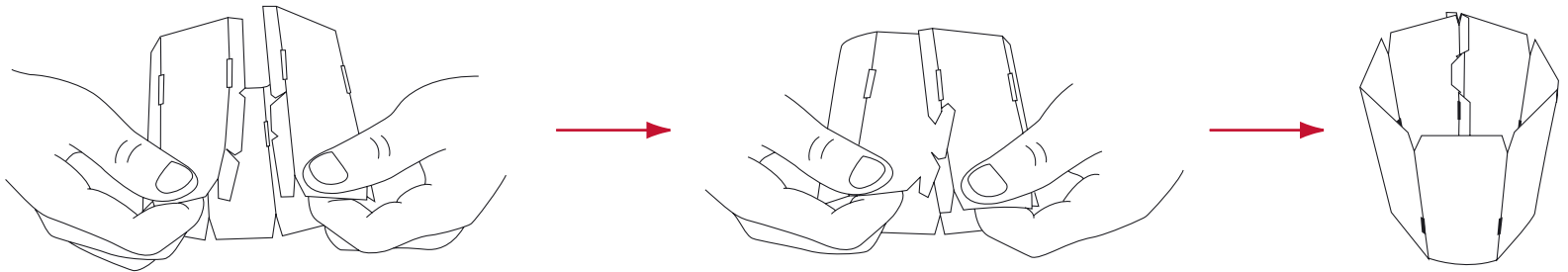

Soklen 'knipses' sammen til en 7-kantet cylinder med den matte side udad.

2.

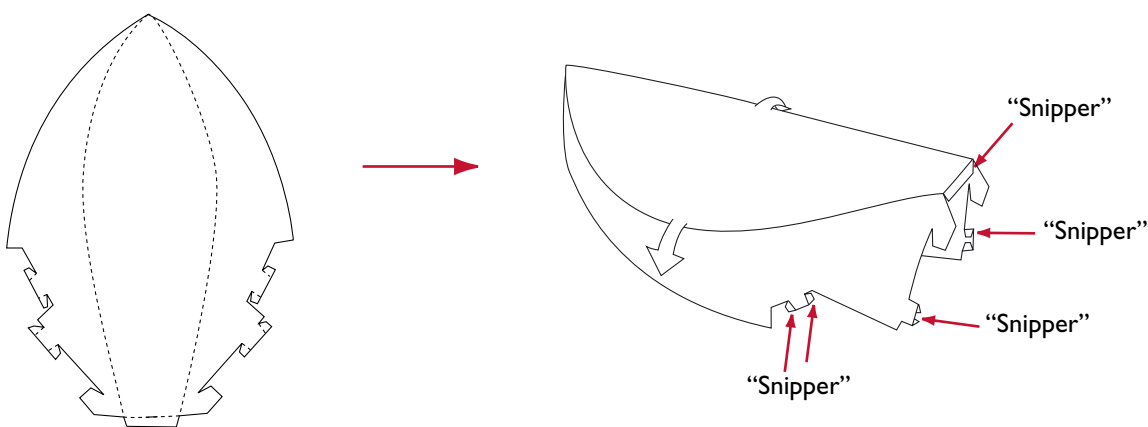

De 7 skærmelementer mærket "2" foldes som vist. Ombøj forsigtigt der hvor skærmelementet buer.

"Snipperne" bøjes ind, så den matte side vender udad.

SAMLEINSTRUKTION NORM 06 SMALL/DANSK

3.



Skærmelementet haspes på den smalle del af åbningen på sokkelementet.

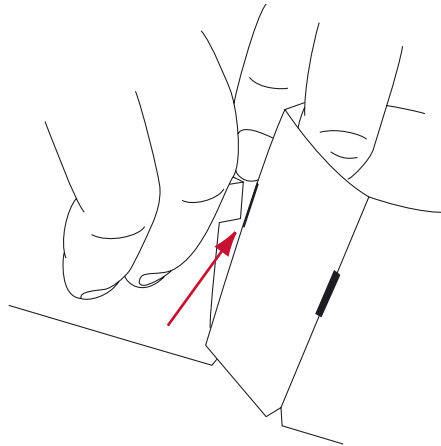

Vend sokkelementet på hovedet og før 'snipperne' igennem hullerne og ombøj 'snipperne' på bagsiden så modulet er låst.

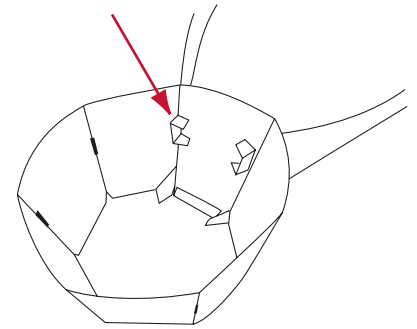

4.

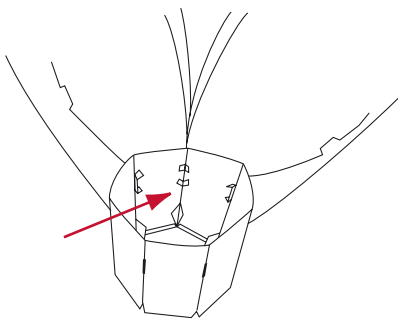

Sæt næste skærmelement på soklen ved siden af de første og fortsæt sådan til alle 7 skærmelementer "2" er monteret. Husk at låse modulerne på indersiden af soklen.

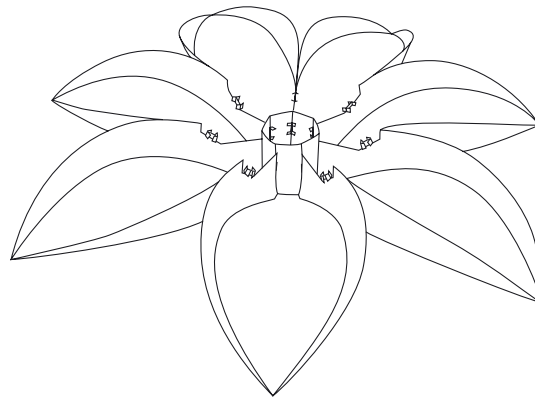

5.

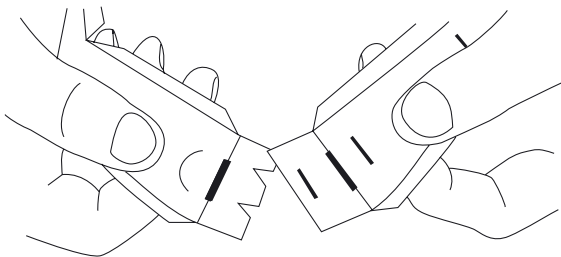

Tag ringelementet mærket "S" og ombøj forstærkningskanterne. Saml ringelementet ved hjælp af 'snipperne'.

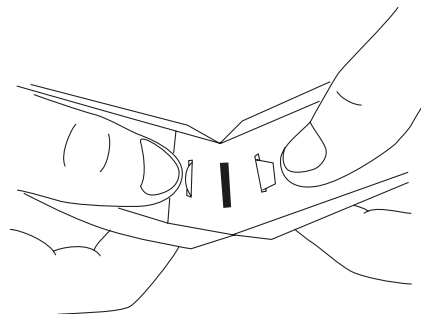

6.

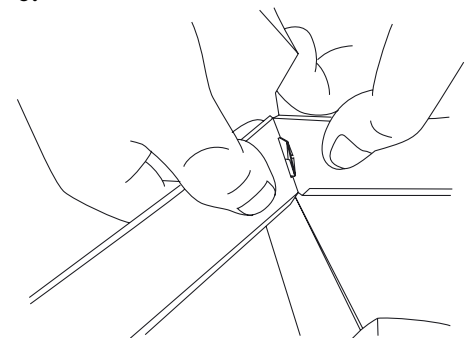

Monter ringelementet "S" på 'snipperne', der sidder på skærmelementet og lås dem ved at rette "snipperne" ud.

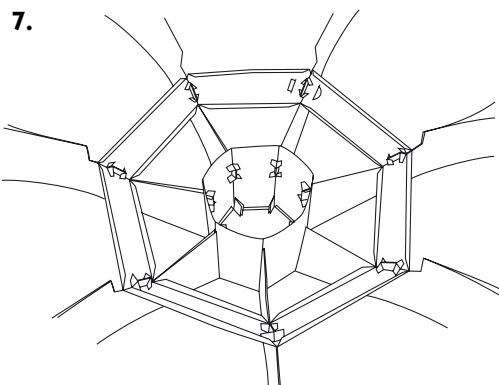

7. Ringelementet korrekt fastmonteret.

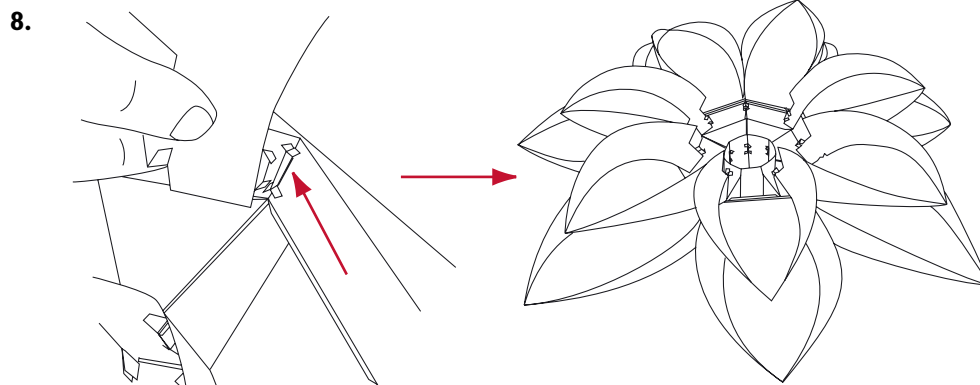

8. Fold de 7 skærmelementer mærket "I". Ombøj forsigtigt hvor skærmelementet buer. Monter første skærmelement på ringelementet ved at stikke 'snipperne' igennem hullet, hvor de andre 'snipper' også sidder.

Monter resten af skærmelementerne på samme måde hele vejen rundt. Husk at låse modulerne på bagsiden.

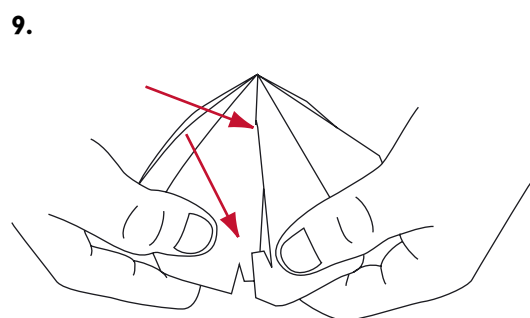

9. Bøj og saml bundmodulet. Sørg for at samlingen vender indad.

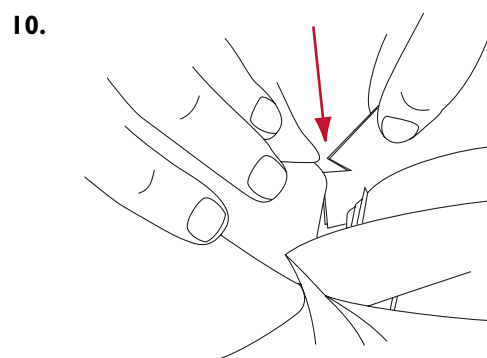

10. Monter bundmodulet i sliderne på de inderste skærmelementer. (Sliderne er de små hakker).

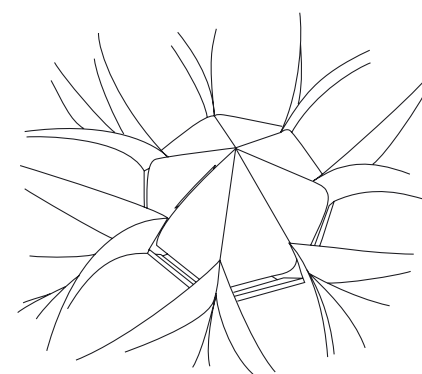

Færdigmonteret bundmodul.

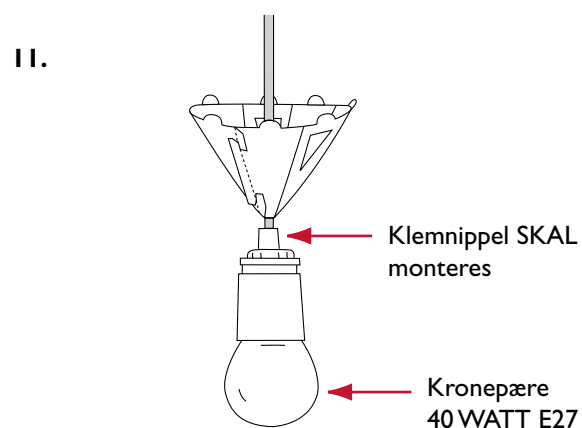

11. Bøj ophængsmodulet i de 6 led og saml det omkring ledningerne, så det har form som et 7-kantet kræmmerhus.

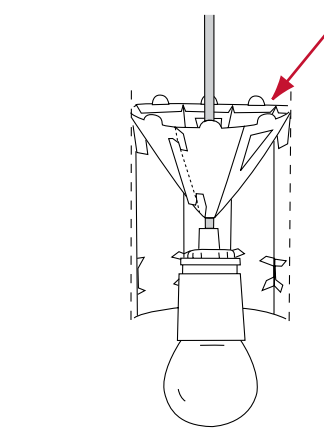

Vend lampen om så åbningen i lampens top vender opad. Sænk ophængsmodulet ned i åbningen og stik 'snipperne' igennem hullerne. Bøj forstærkningskanterne ned i vandret, så det låser ophængsmodulet.

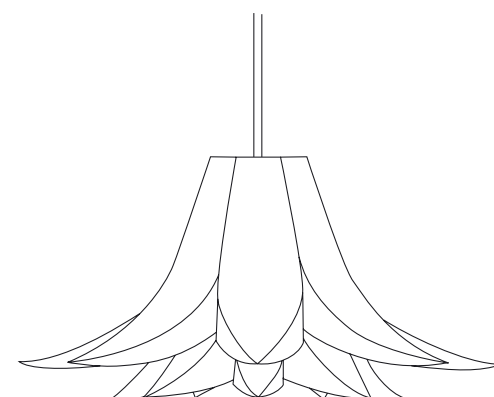

Færdigmonteret lampe klar til ophængning. Lampen kan hænges op uden at afmontere lampefatning. Udskiftning af pære kan nemt foretages gennem lampens fleksible bund.

MAKS 40 WATT

MONTERINGSINSTRUKTIONER NORM 06 SMALL/SVENSKA

Innehåll:

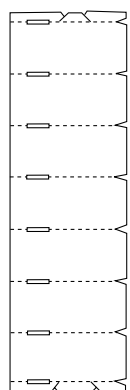

1 basenhet

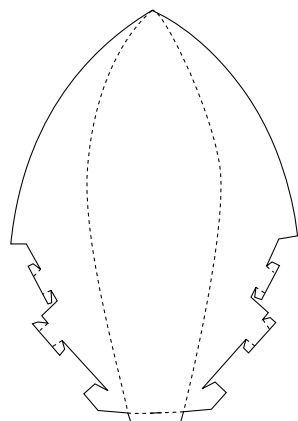

7 lampskärmsenheter 2

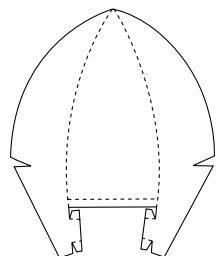

7 lampskärmsenheter 1

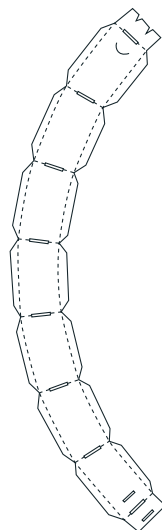

1 ringenhet S

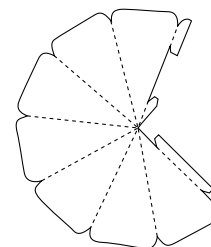

1 basmodul

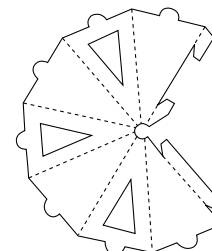

1 upphängningsmodul

Monteringsinstruktioner:

1.

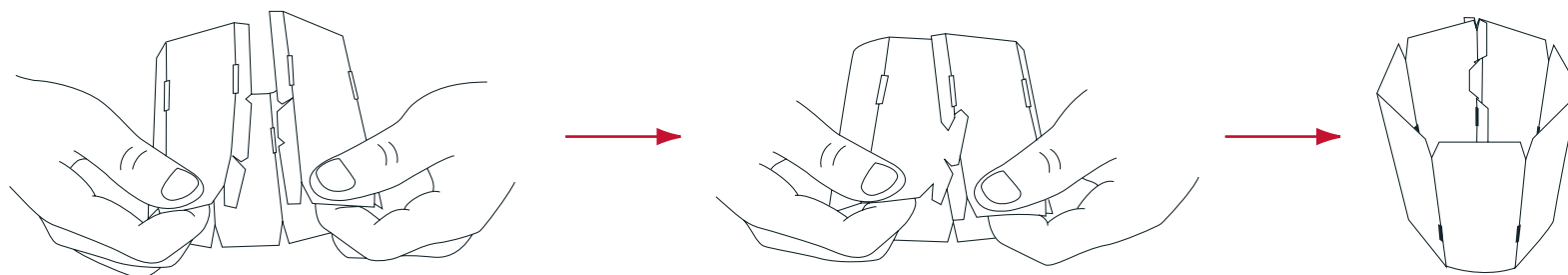

Sätt ihop basen till en 7-sidig cylinder med den matta sidan utåt.

2.

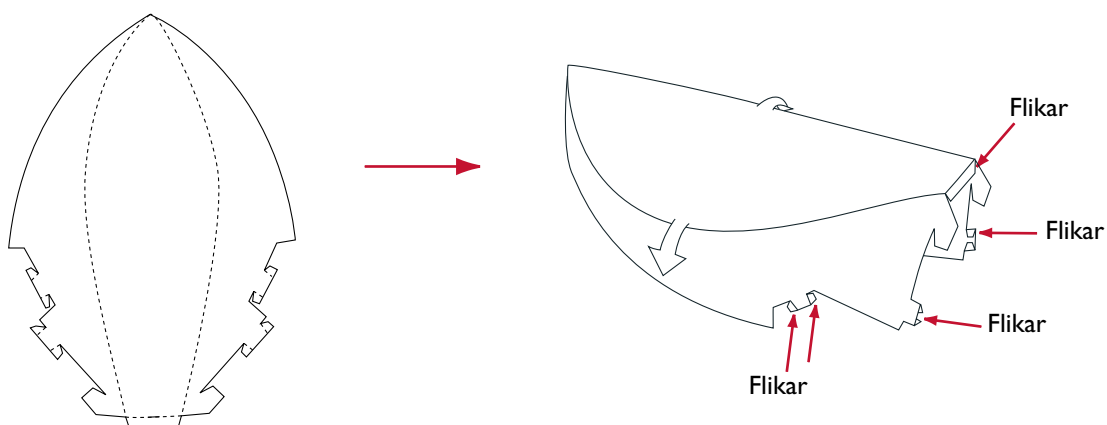

Vik de 7 lampskärmsenheterna markerade med "2" som visat. Vik försiktigt längs med skärmenhetens kurva.

Vik in flikarna med den matta sidan utåt.

3.

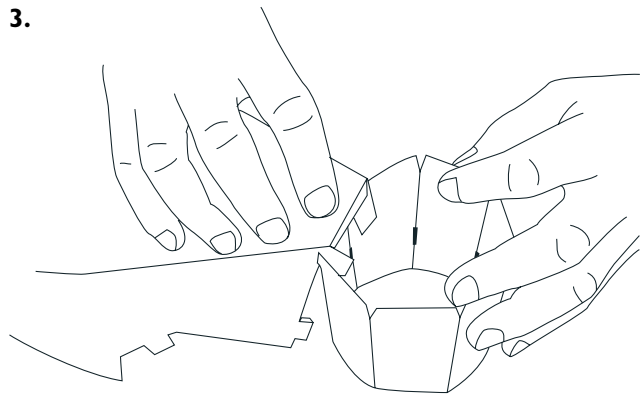

Haka fast skärmenheten till den smala delen av basenhetens öppning.

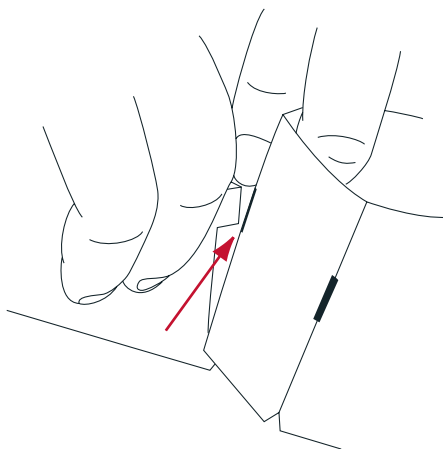

Vänd basenheten upp och ned och för flikarna genom hålen. Vik över dem på baksidan för att låsa modulen.

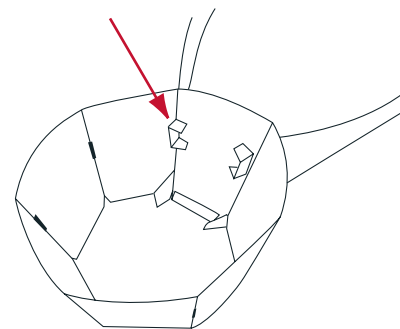

4.

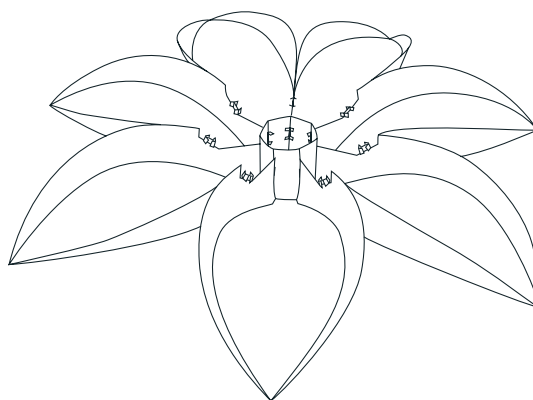
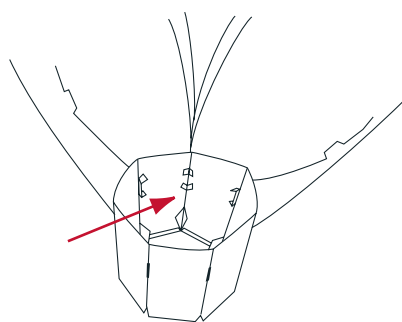

Placera nästa skärmenhet på basen intill det första och fortsätt tills alla 7 lampskärmsenheter markerade med "2" har monterats. Kom ihåg att låsa modulerna på basens insida.

5.

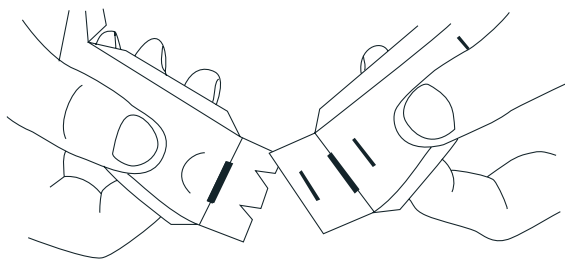

Ta ringenheten markerad med "S" och vik över de stärkande kanterna. Montera ringenheten genom att använda flikarna.

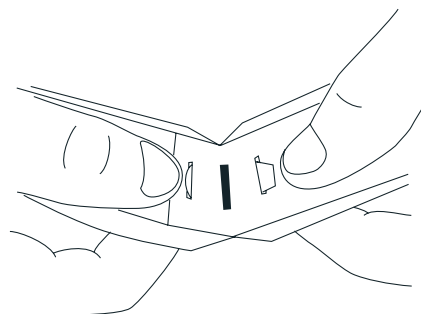

6.

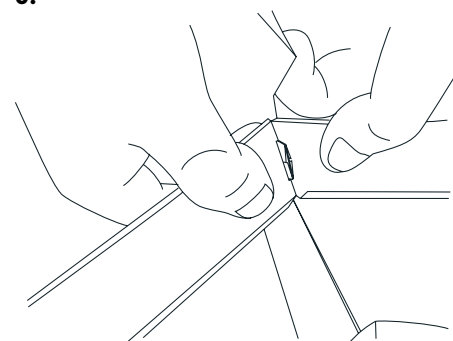

Montera ringenheten "S" på flikarna på lampskärmsenheten och lås dem genom att rätta ut flikarna.

MONTERINGSINSTRUKTIONER TILL NORM 06 SMALL/SVENSKA

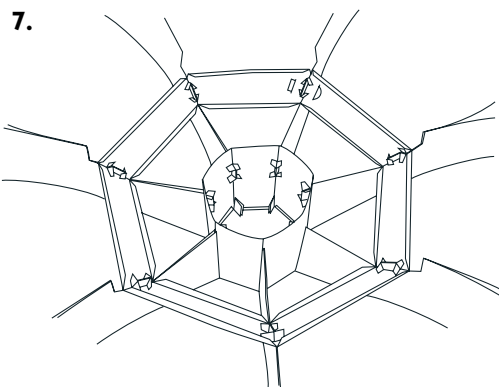

Korrekt monterad ringenhet.

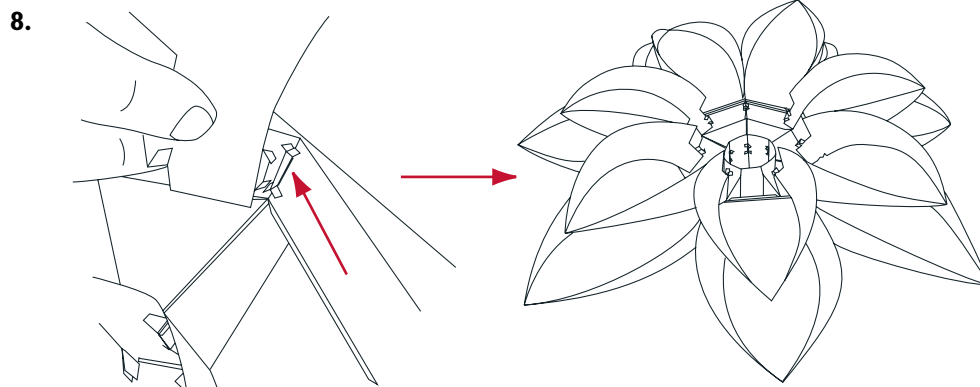

Vik de 7 lampskärmsenheterna markerade med "1". Vik försiktigt över längs med skärmenhetens kurva. Montera den första skärmenheten på ringenheten genom att föra flikarna genom hålet där de andra flikarna också är lokaliserade.

Montera resten av lampskärmsenheterna på liknande sätt hela vägen runt. Kom ihåg att låsa modulerna på baksidan.

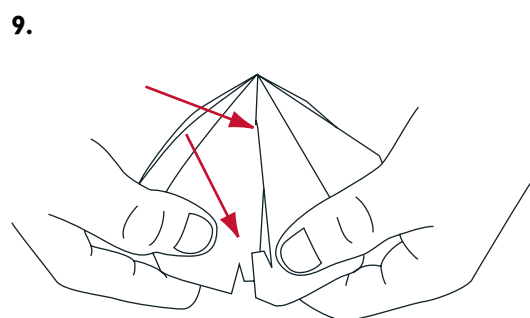

Böj och montera basmodulen. Säkerställ att skarvarna är vända inåt.

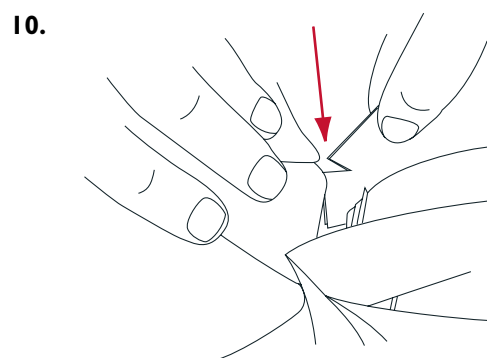

Fäst basmodulen i springorna på de inre lampskärmsenheterna. (Springorna är de små utskurna hålen.)

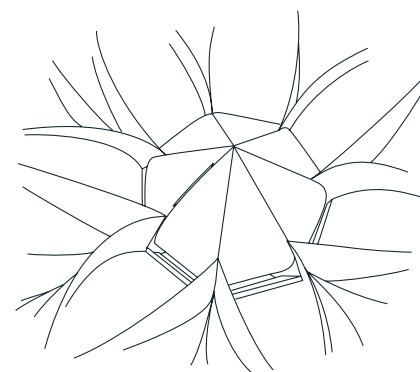

Den färdigmonterade basmodulen.

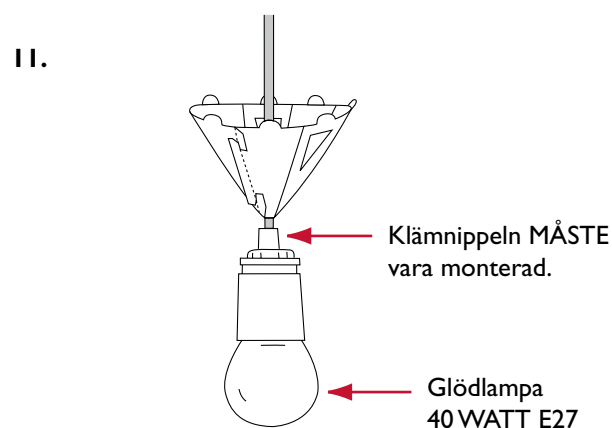

Böj upphängningsmodulen i de 6 riktningarna och montera runt vajrarna så att de formar en 7-sidig kon.

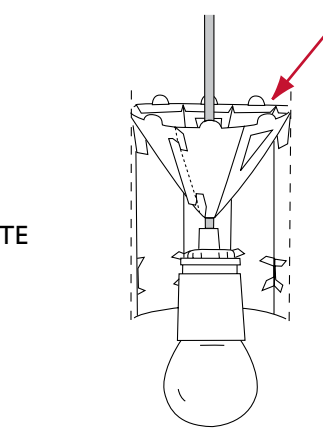

Vrid runt lampan så att öppningen på lampans topp vänds uppåt. Sänk upphängningsmodulen in i öppningen och för flikarna genom hålen. Vik ned de stärkande kanterna horisontalt så att de låser upphängningsmodulen.

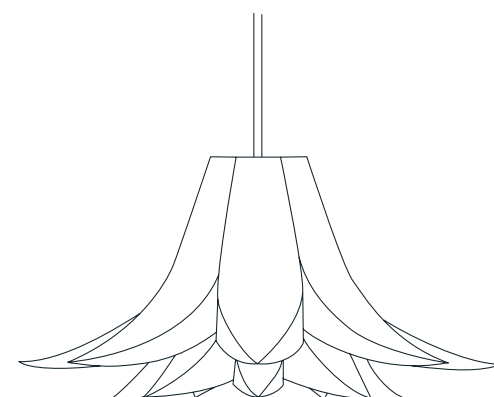

Den färdigmonterade lampan är redo att hängas upp. Lampan kan hängas upp utan att ta bort lamparmaturen. Glödlampor kan enkelt bytas genom lampans flexibla bas.

MAX 40 WATT

Innhold:

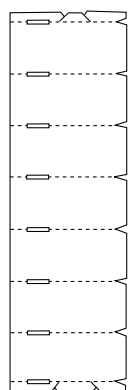

1 grunnelement

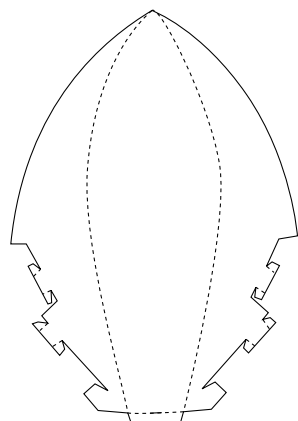

7 lampeskjermelementer, nr. 2

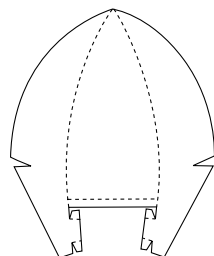

7 lampeskjermelementer, nr. 1

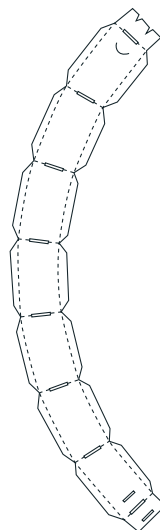

1 ringelement S

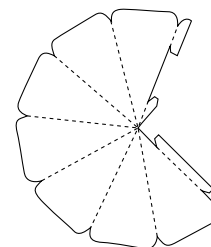

1 grunnmodul

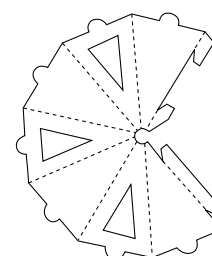

1 opphengingsmodul

Monteringsinstruksjoner:

1.

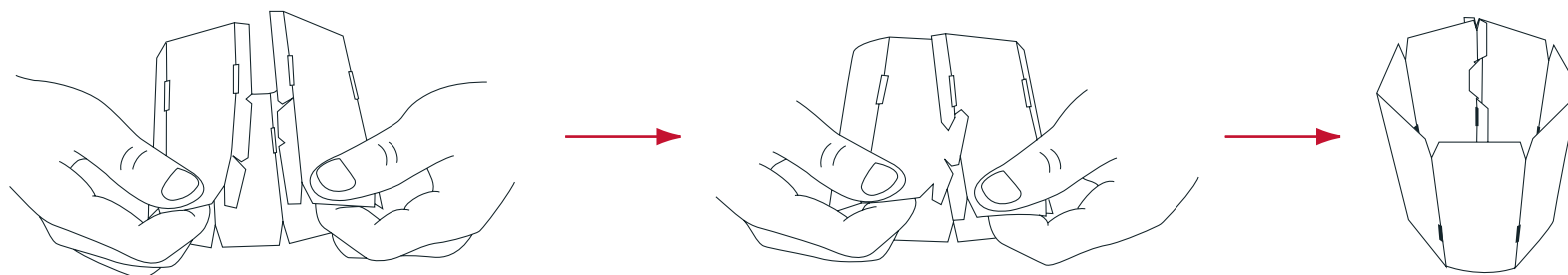

Klikk grunnelementene sammen i en sylinder med sju sider, med den matte siden ut.

2.

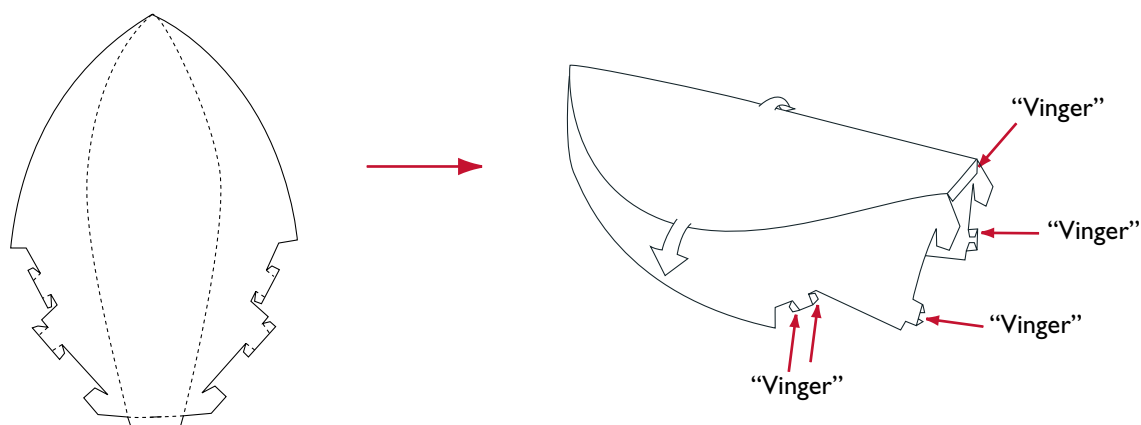

Brett de sju lampeskjermelementene merket 2, som vist. Brett forsiktig langs buen på skjermelementet.

Brett inn "vingene", slik at den matte siden vender ut.

MONTERINGSINSTRUKSJONER NORM 06 SMALL/NORSK

3.

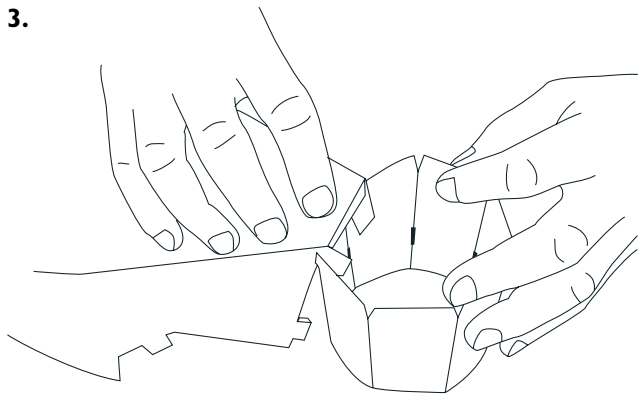

Hekt skjermelementet på den smale delen av åpningen på grunnelementet.

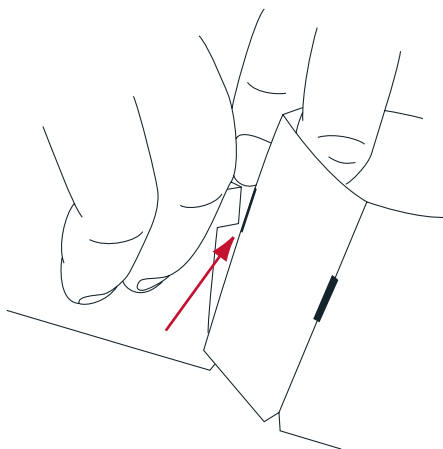

Snu grunnelementet opp-ned og før vingene gjennom hullene, brett dem over baksiden slik at modulen låses.

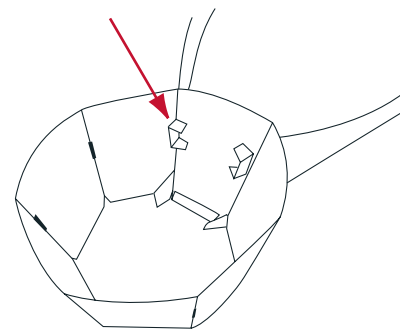

4.

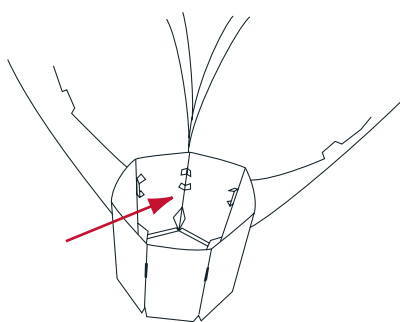

Sett det neste skjermelementet på grunnelementet ved siden av det første, og fortsett til alle sju lampeskjermelementene, nr. 2. er festet. Husk å låse modulene på innsiden av grunnelementet.

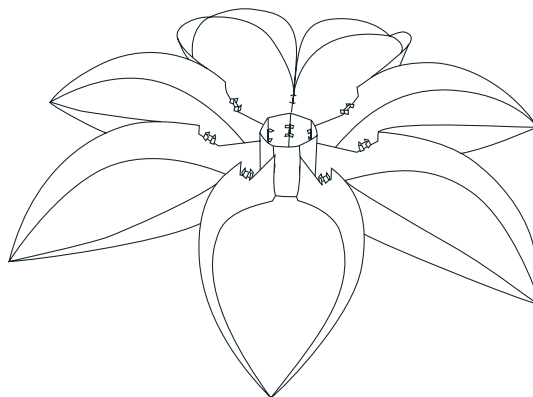

5.

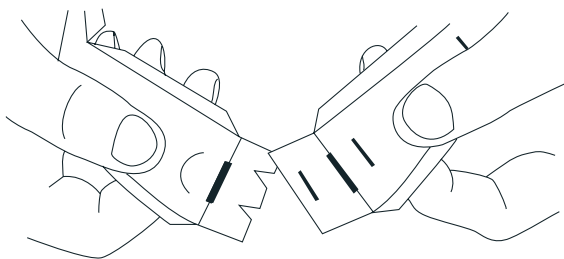

Ta ringelementet merket S og brett forsterkningskantene over. Monter ringelementet ved hjelp av "vingene".

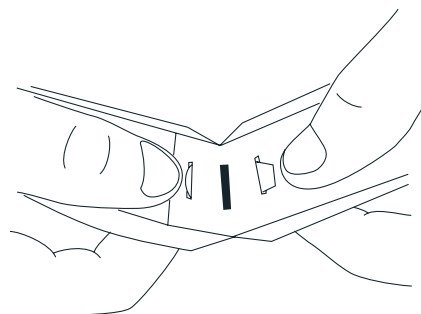

6.

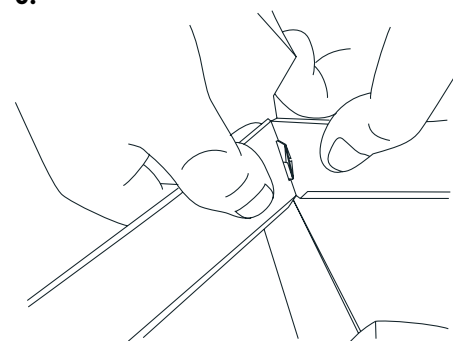

Sett ringelementet S på "vingene" på lampeskjermelementet, og lås dem ved å rette ut "vingene".

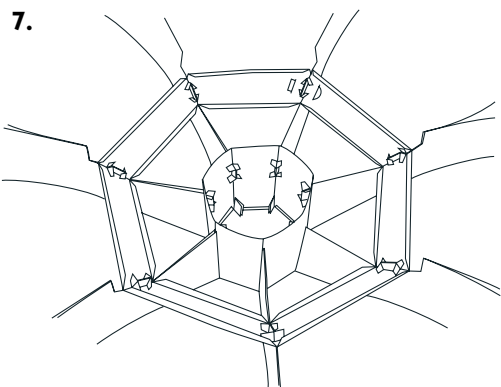

Riktig montert ringelement

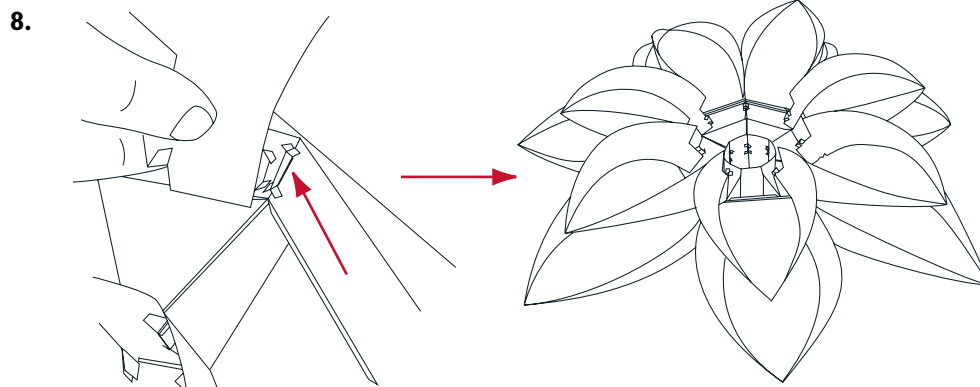

Brett de sju lampeskjermelementene merket 1. Brett forsiktig over langs buen på skjermelementet. Fest det første skjermelementet på ringelementet ved å skyve "vingene" gjennom hullet, der de andre "vingene" også er festet.

Fest resterende lampeskjermelementer på samme måte, hele veien rundt. Husk å låse modulene på baksiden.

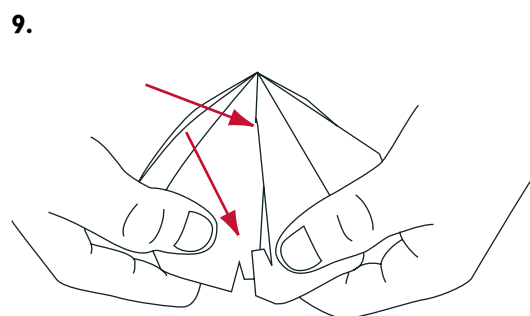

Bøy og monter grunnmodulen. Pass på at skjøtene vender innover.

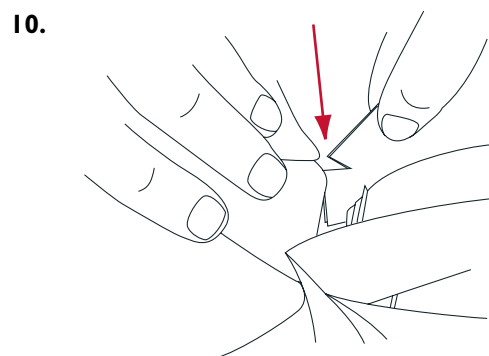

Fest grunnmodulen i slissene på de innerste lampeskjermelementene. (Slissene er små utsparinger.)

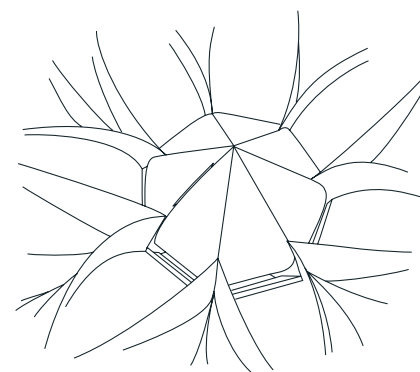

Den ferdigmonterte grunnmodulen.

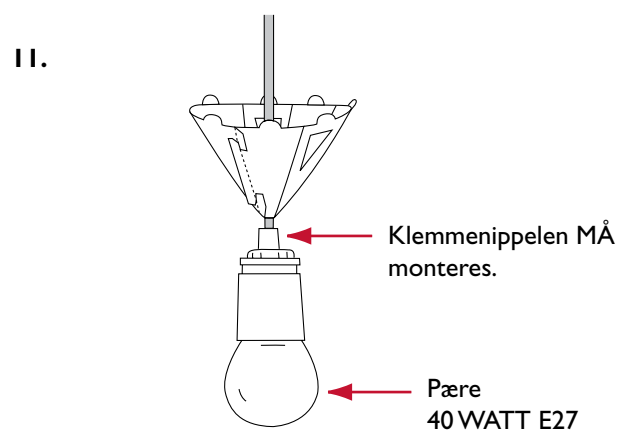

Bøy opphengingsmodulen i de seks retningene og monter den rundt ledningene slik at den former en kjeGLE med sju sider.

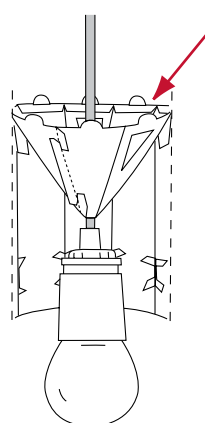

Drei lampen slik at åpningen øverst i lampen vender opp. Før opphengingsmodulen ned i åpningen og skyv "vingene" gjennom hullene. Brett ned forsterkningskantene vannrett slik at de låser opphengingsmodulen.

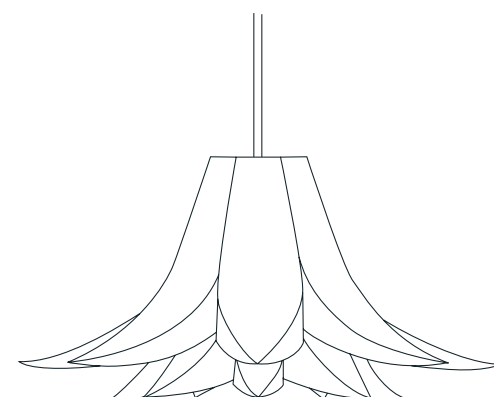

Den ferdigmonterte lampen klar til opphenging. Lampen kan henges opp uten at lyspærefestet fjernes. Det er enkelt å skifte pære takket være den fleksible lampesokkelen.

MAKS. 40 WATT

ASSEMBLY INSTRUCTIONS NORM 06 SMALL/ENGLISH

Contents:

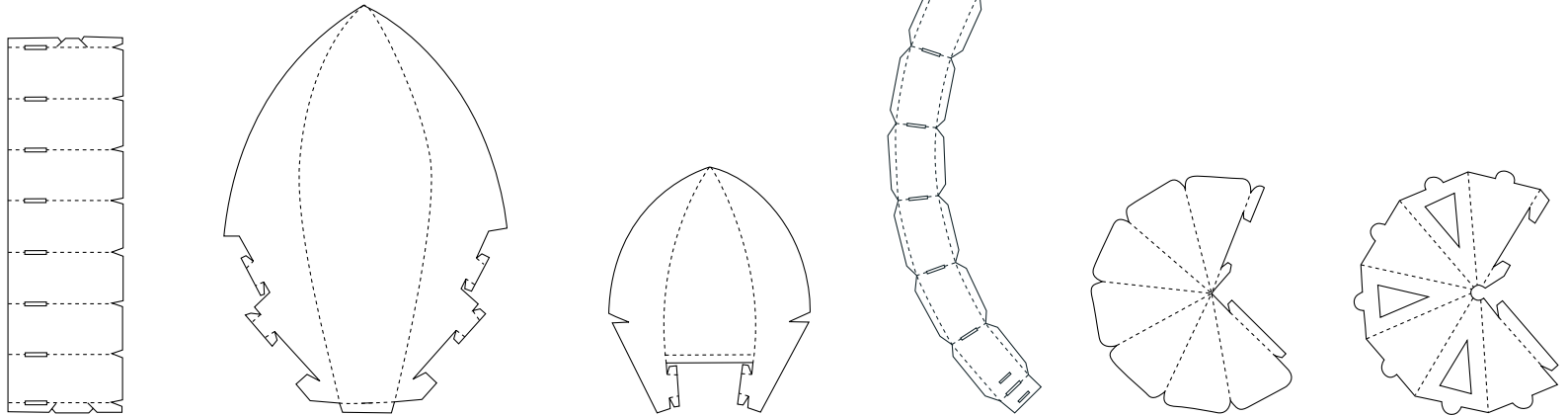

1 base element

7 lampshade elements
no. 2

7 lampshade elements
no. 1

1 ring element
S

1 base module

1 suspension
module

Assembly instructions:

1.

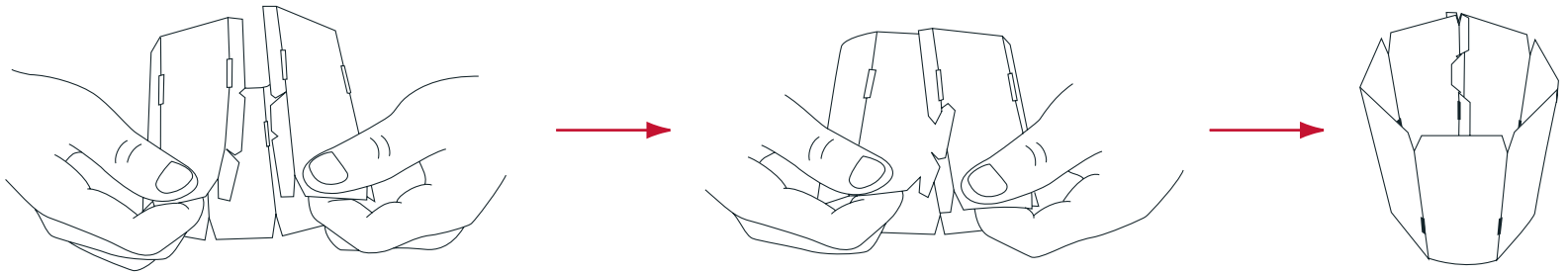

'Snap' the base together into a 7-sided cylinder with the matt side out.

2.

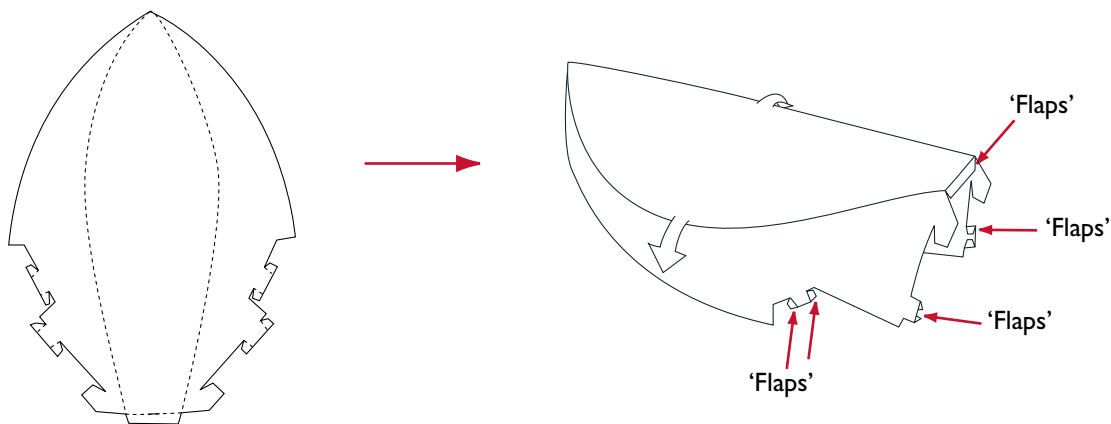

Fold the 7 lampshade elements marked '2' as shown. Fold carefully along the curve of the shade element.

Fold the 'flaps' in with the matt side out.

3.

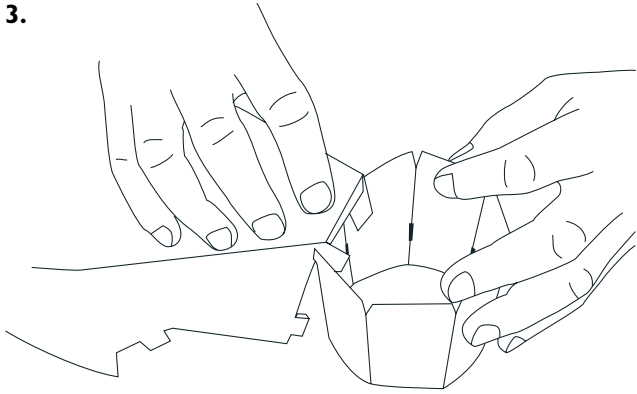

Hook the shade element onto the narrow part of the opening on the base element.

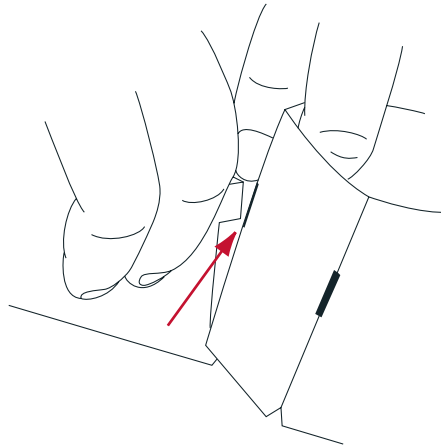

Turn the base element upside down and guide the 'flaps' through the holes, folding them over at the back to lock the module.

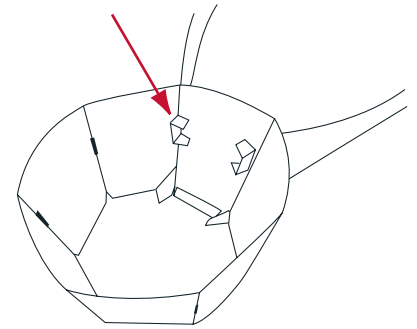

4.

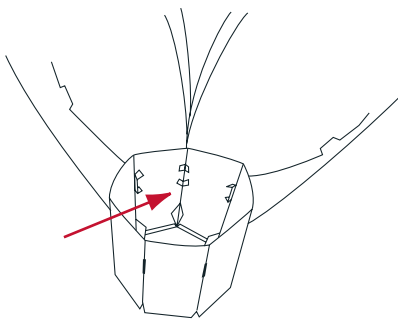

Place the next shade element onto the base next to the first one and continue until all 7 lampshade elements '2' have been mounted. Remember to lock the modules on the inside of the base.

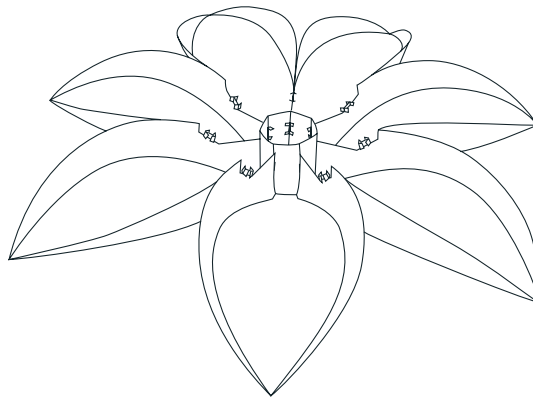

5.

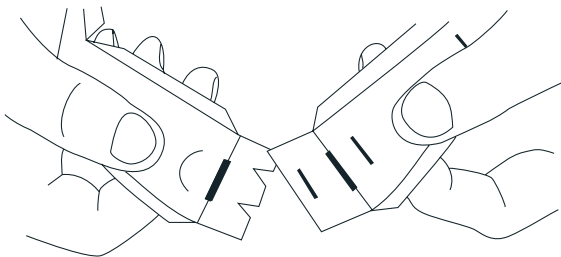

Take the ring element marked 'S' and fold the strengthening edges over. Assemble the ring element using the 'flaps'.

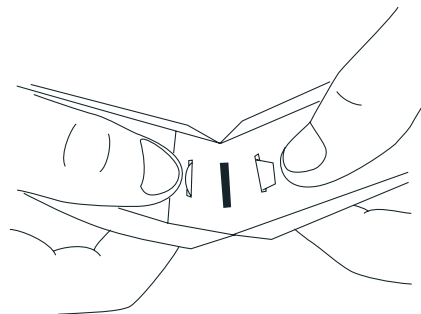

6.

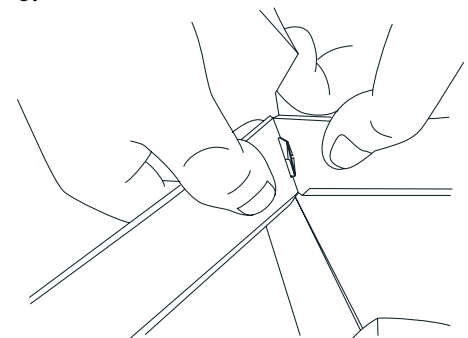

Mount ring element 'S' onto the 'flaps' on the lampshade element and lock them by straightening out the 'flaps'.

ASSEMBLY INSTRUCTIONS NORM 06 SMALL/ENGLISH

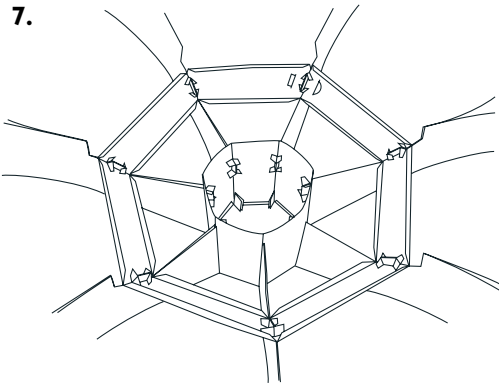

Correctly mounted ring element.

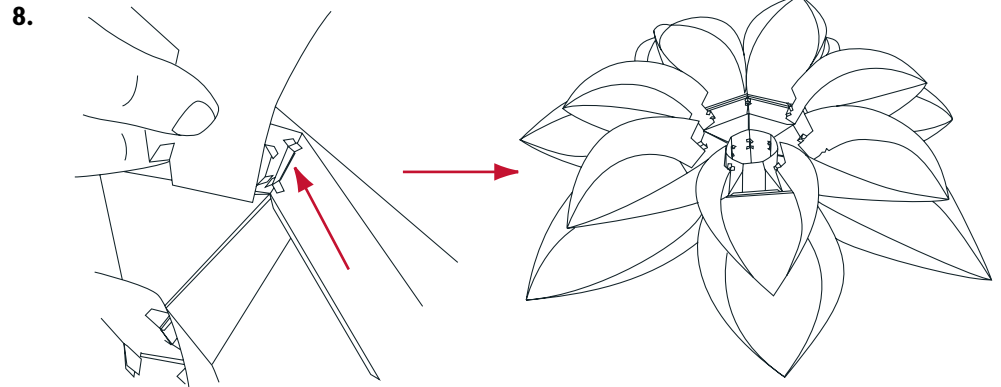

Fold the 7 lampshade elements marked '1'. Fold over carefully along the curve of the shade element. Mount the first shade element onto the ring element by pushing the 'flaps' through the hole where the other 'flaps' are also located.

Mount the rest of the lampshade elements similarly all the way round. Remember to lock the modules at the back.

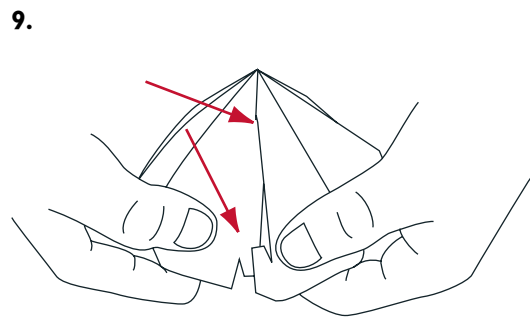

Bend and assemble the base module. Make sure joints turn inwards.

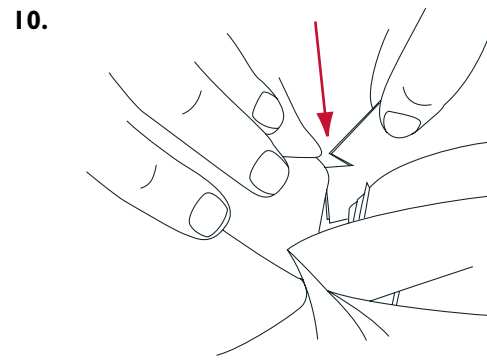

Fit the base module into the slots on the inner lampshade elements. (The slots are the small cut-outs).

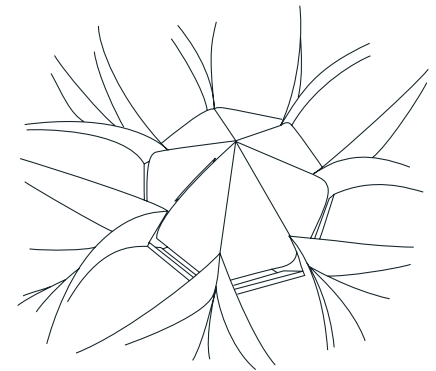

The fully assembled base module.

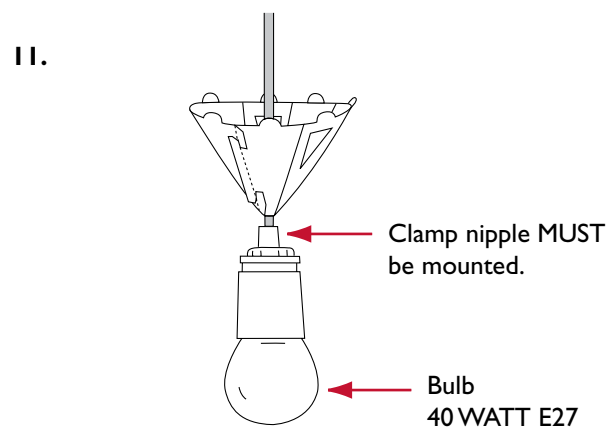

Bend the suspension module in the 6 directions and assemble around the wires so as to form a 7-sided cone.

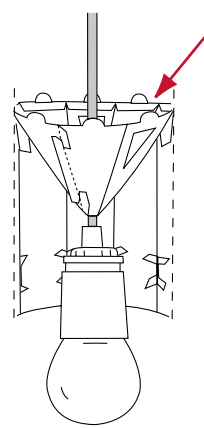

Turn the lamp around so the opening at the top of the lamp is turned upwards. Lower the suspension module into the opening and push the 'flaps' through the holes. Turn down the strengthening edges horizontally so they lock the suspension module.

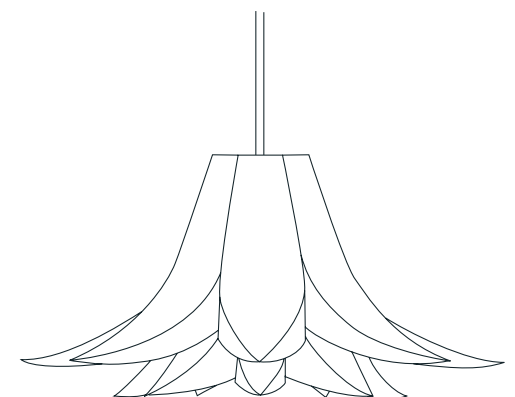

The fully assembled lamp ready for hanging. The lamp can be hung without removing the light fitting. Bulbs can be easily changed through the flexible base of the lamp.

MAX 40 WATT

Inhalt:

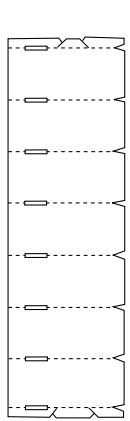

1 Sockelelement

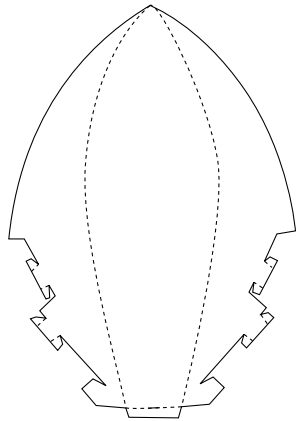

7 Lampenschirmelemente
Nr. 2

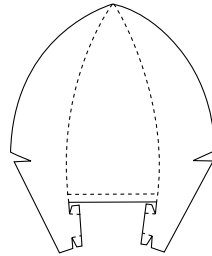

7 Lampenschirmelemente
Nr. 1

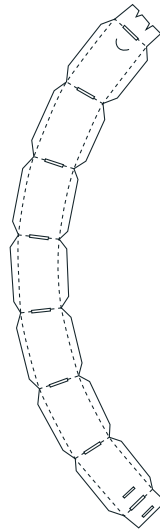

1 Ringelement S

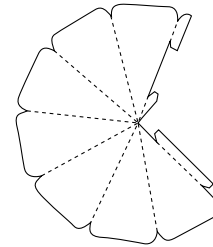

1 Mittelteil

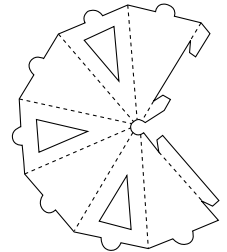

1 Befestigungsteil

Montageanleitung:

1.

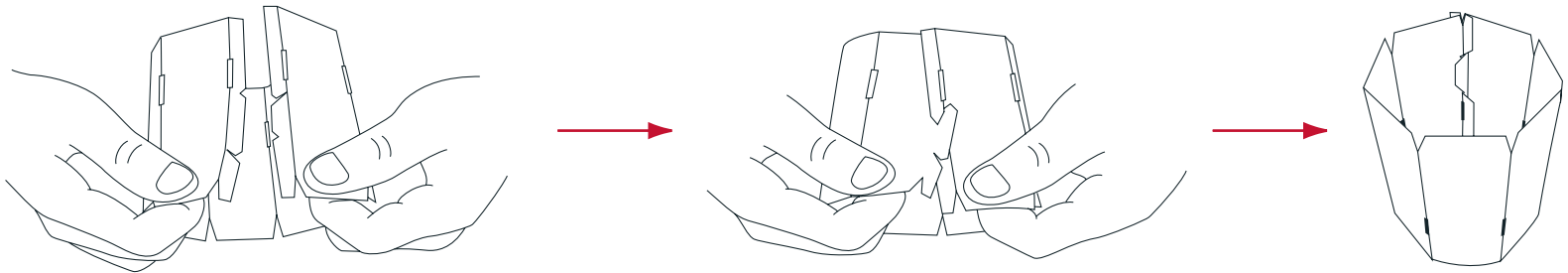

Knipfen Sie die Sockelelement so zusammen, dass ein 7-seitiger Zylinder entsteht, die matte Seite nach außen.

2.

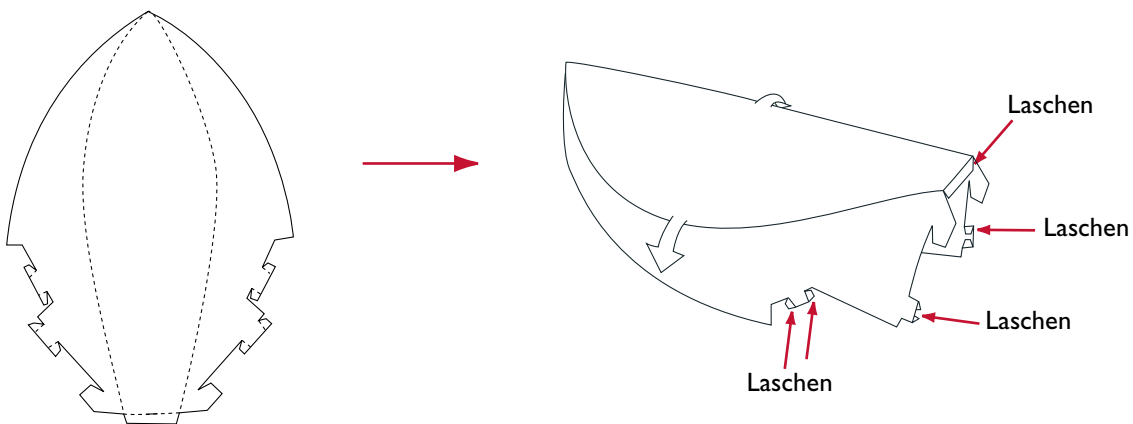

Falten Sie die 7 Lampenschirmelemente Nr. 2 wie angegeben. Falten Sie vorsichtig entlang der Rundung des Schirmelements.

Knipfen Sie die Laschen nach innen, matte Seite nach außen.

MONTAGEANLEITUNG NORM 06 SMALL/DEUTSCH

3.



Haken Sie das Schirmelement an der engeren Öffnung des Sockelelements ein.

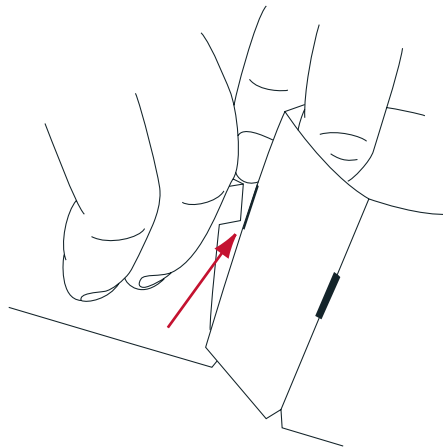

Wenden Sie das Ganze. Führen Sie die Laschen durch die Schlitzte und knicken Sie sie hinten um, um das Schirmelement zu fixieren.

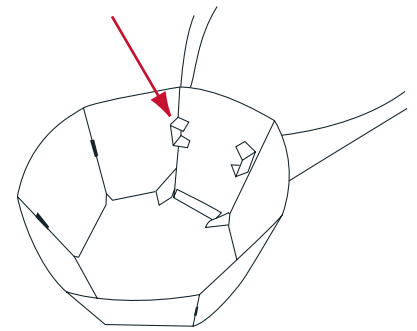

4.

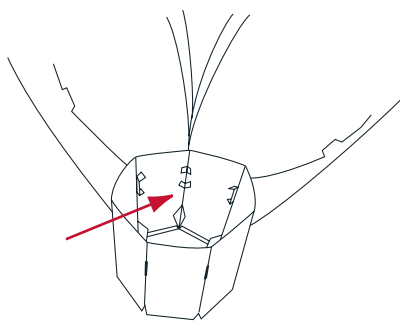

Befestigen Sie das nächste Schirmelement neben dem ersten, und tun Sie dasselbe mit den restlichen Lampenschirmelementen Nr. 2. Vergessen Sie nicht, die Elemente auf der Innenseite des Sockelelements zu fixieren.

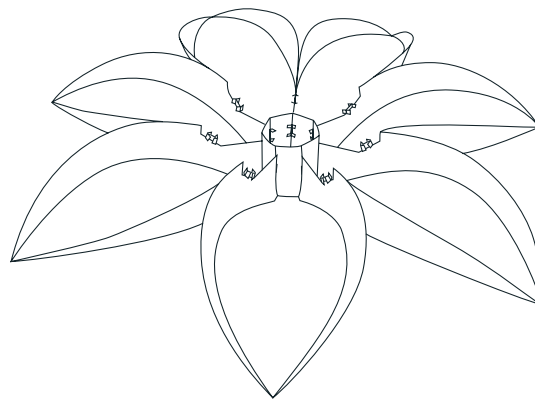

5.

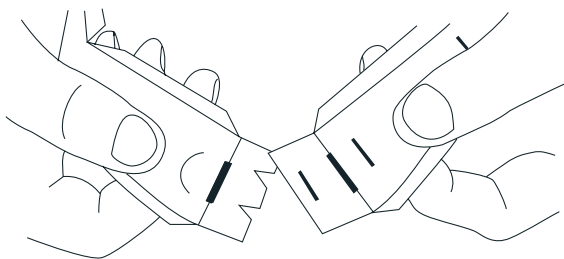

Nehmen Sie das Ringelement S und knicken Sie die Kanten zur Verstärkung nach innen. Setzen Sie den Ring mit Hilfe der Laschen zusammen.

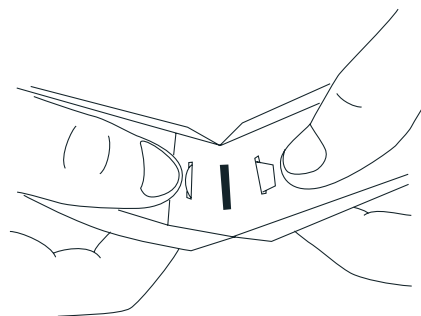

6.

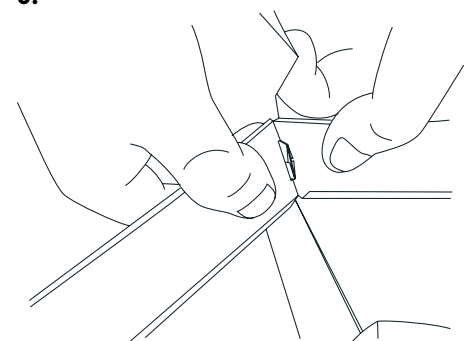

Setzen Sie das Ringelement S auf die dafür vorgesehenen Laschen auf den Lampenschirmelementen und fixieren Sie es, indem Sie die Laschen auseinanderfalten.

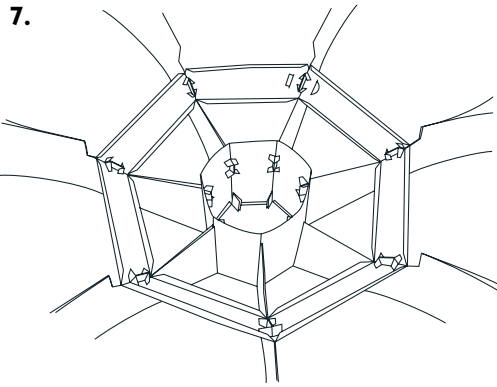

Korrekt aufgesetztes Ringelement.

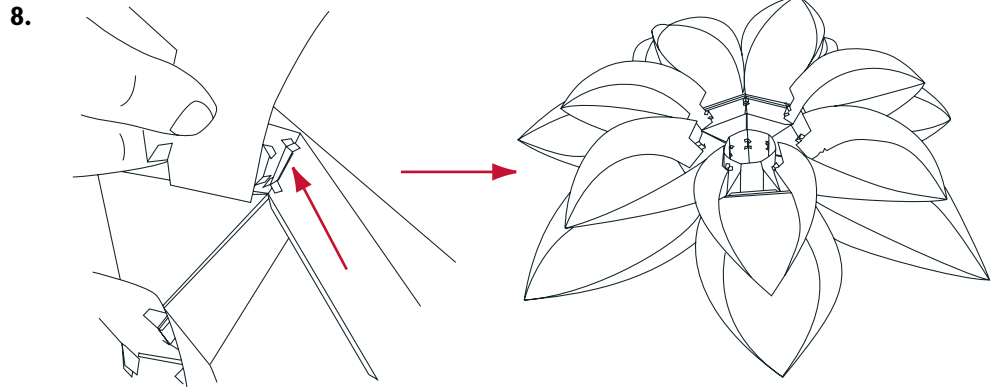

Falten Sie die 7 Lampenschirmelemente Nr. 1. Falten Sie vorsichtig entlang der Rundung des Schirmelements. Setzen Sie das erste Schirmelement Nr. 1 auf das Ringelement, indem Sie die Laschen durch den selben Schlitz führen, wie diejenigen des Schirmelements Nr. 2.

Tun Sie rundherum das selbe mit den restlichen Lampenschirmelementen Nr. 1. Vergessen Sie nicht, die Elemente hinten zu fixieren.

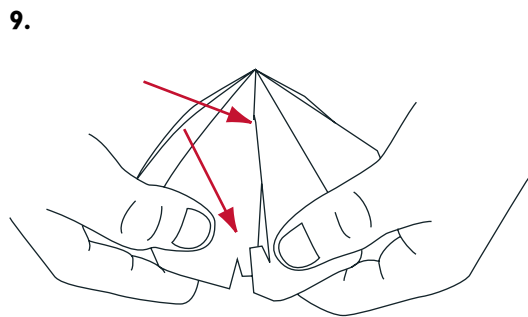

Formen Sie das Mittelteil und setzen Sie es zusammen. Achten Sie darauf, die Verbindungen nach innen zu wenden.

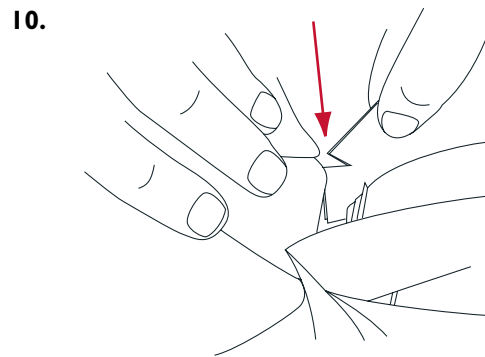

Befestigen Sie das Mittelteil in den Steckschlitzen auf der Innenseite der Lampenschirmelemente. (in den kleinen Einschnitten).

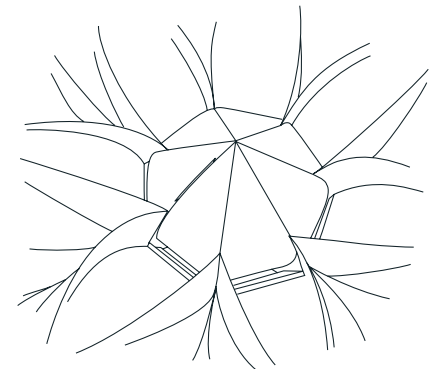

Das vollständig befestigte Mittelteil.

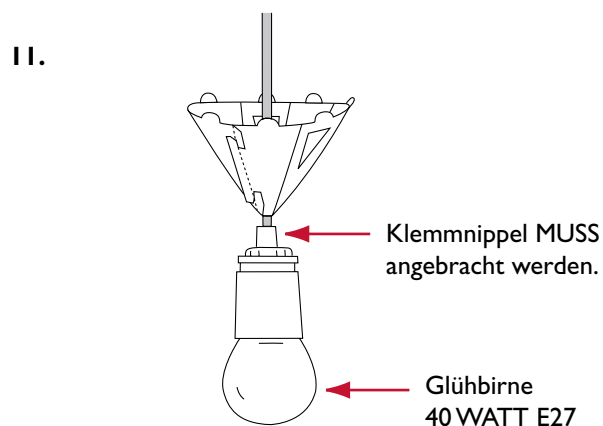

Formen Sie das Befestigungsteil und setzen Sie es so um das Kabel zusammen, dass ein 7-seitiger Kegel entsteht.

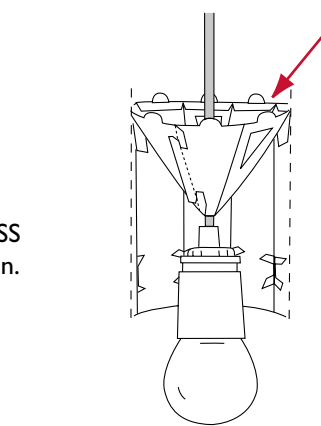

Wenden Sie die Lampe so, dass ihre obere Öffnung nach oben zu liegen kommt. Senken Sie das Befestigungsteil in die Öffnung und führen Sie die Laschen durch die Schlitzze. Knicken Sie die Kanten zur Stärkung horizontal, damit sie das Befestigungsteil fixieren.

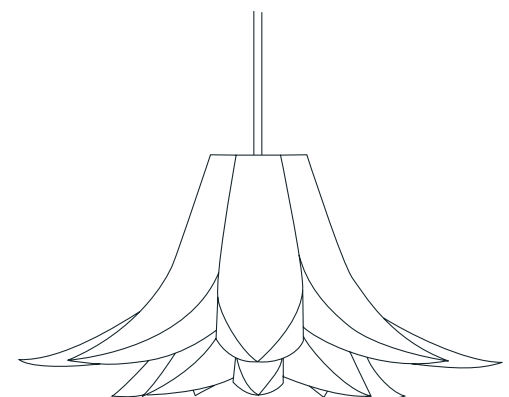

Die vollständig montierte Leuchte bereit zum Aufhängen. Die Leuchte kann aufgehängt werden, ohne dass der Beleuchtungskörper entfernt werden muss. Dank des flexiblen Sockelelements können Glühlampen einfach ausgetauscht werden.

MAX. 40 WATT

INSTRUCTIONS D'ASSEMBLAGE NORM 06 SMALL/FRANCAIS

Contenu :

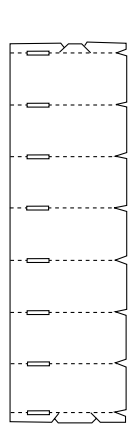

1 socle

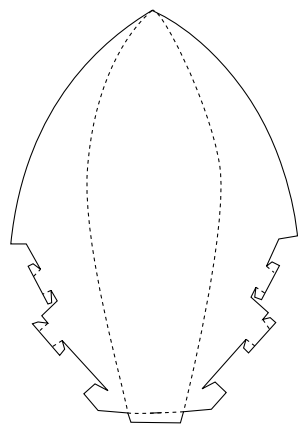

7 abats-jour n°2

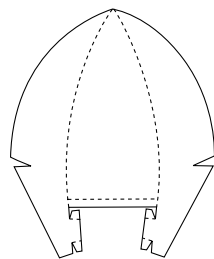

7 abats-jour n°1

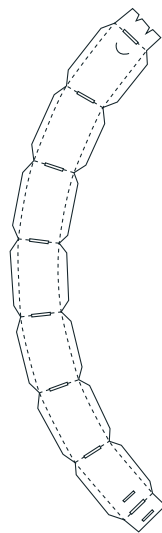

1 anneau S

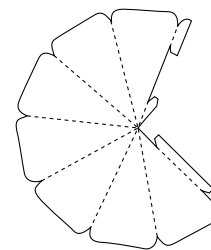

1 module de base

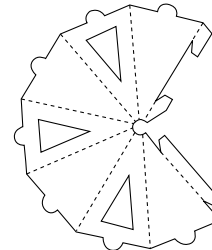

1 module de suspension

Instructions d'assemblage :

1.

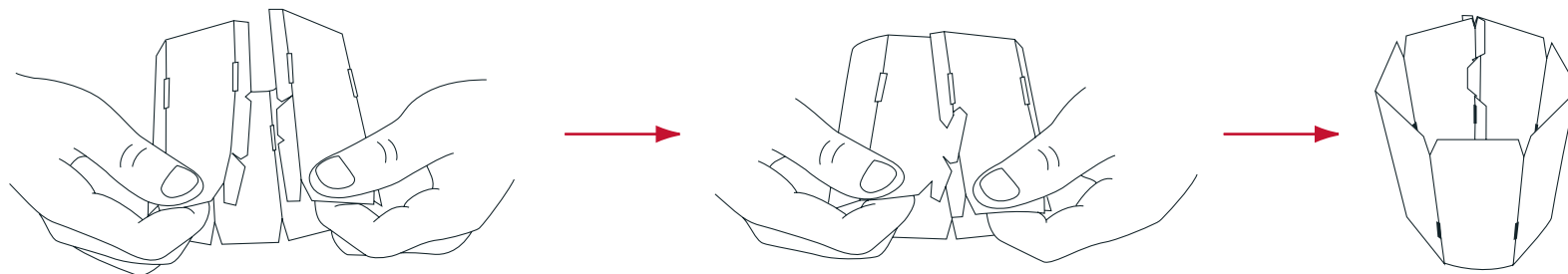

Enclenchez la base dans le cylindre heptagonal avec le côté mat vers l'extérieur.

2.

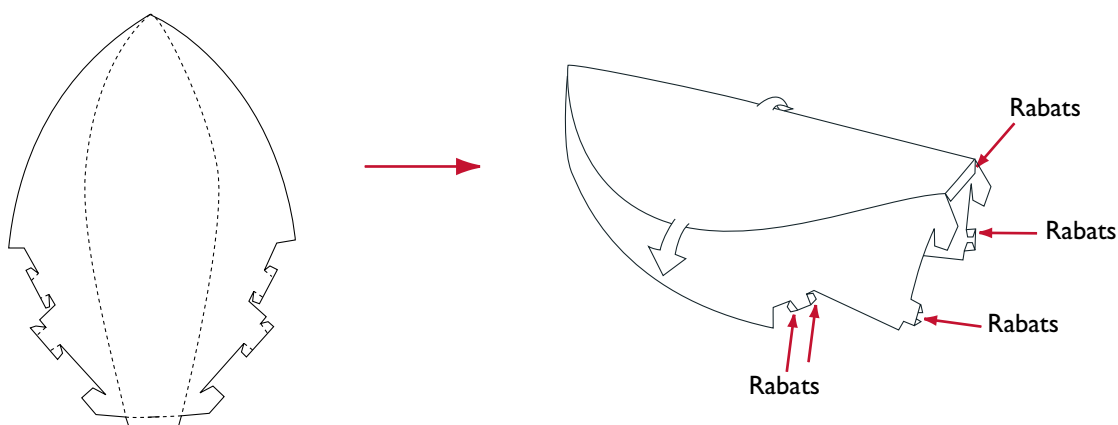

Pliez les 7 abats-jour comportant le chiffre '2', tel que cela est indiqué. Pliez soigneusement le long de la courbe de l'abat-jour.

Pliez les rabats avec le côté mat vers l'extérieur.

3.

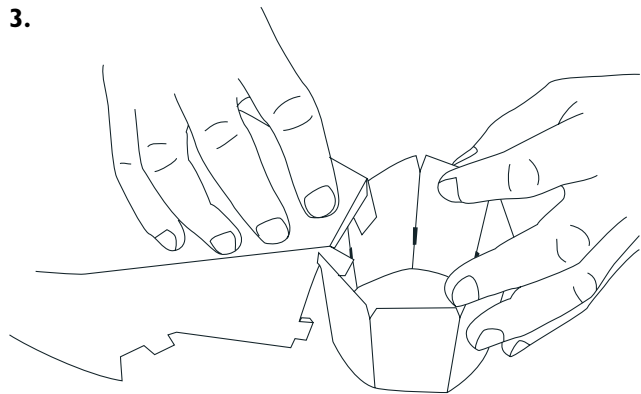

Accrochez l'abat-jour sur la partie étroite de l'ouverture du socle.

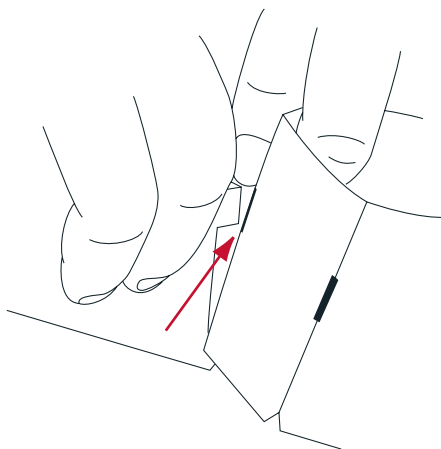

Tournez le socle dans l'autre sens et insérez les rabats dans les trous, en les pliant à l'arrière pour verrouiller le module.

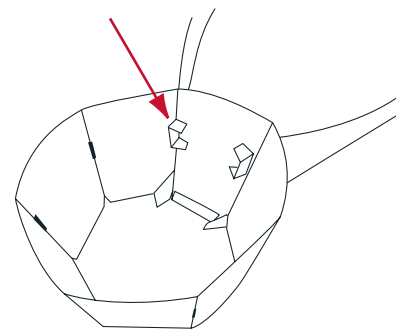

4.

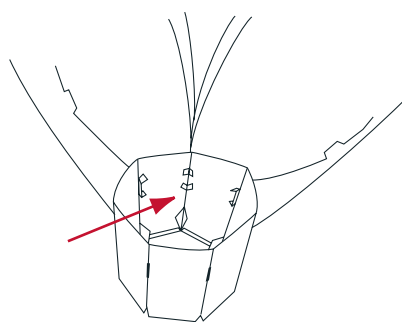

Placez l'abat-jour suivant sur le socle suivant et continuez jusqu'à fixation des 7 abat-jour comportant le chiffre '2'. Veillez à verrouiller les modules à l'intérieur de la base.

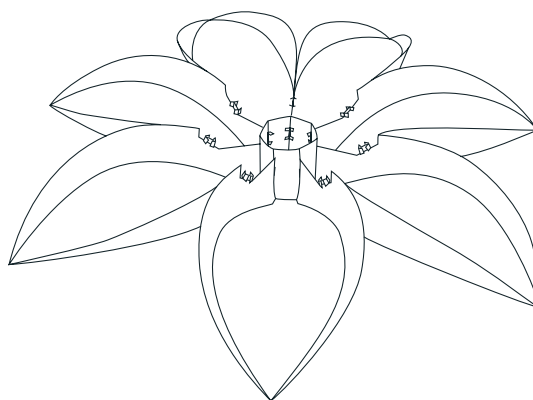

5.

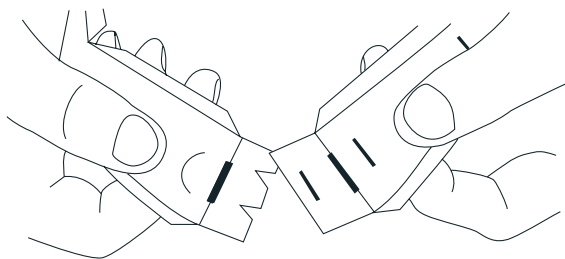

Prenez l'anneau comportant la lettre 'S' et repliez les bords renforcés. Assemblez l'anneau à l'aide des rabats.

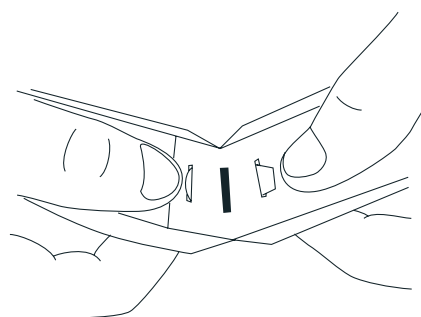

6.

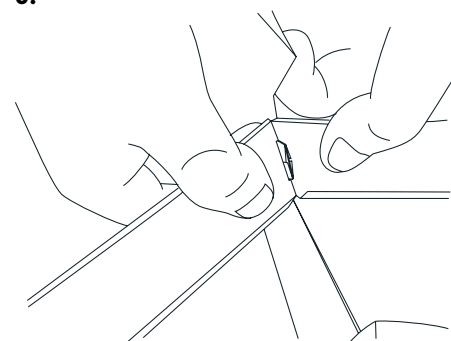

Montez l'anneau 'S' sur les rabats de l'abat-jour et verrouillez-les en redressant les rabats.

INSTRUCTIONS D'ASSEMBLAGE NORM 06 SMALL/FRANCAIS

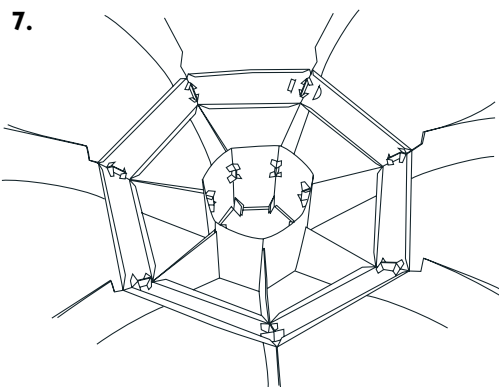

Anneau correctement monté.

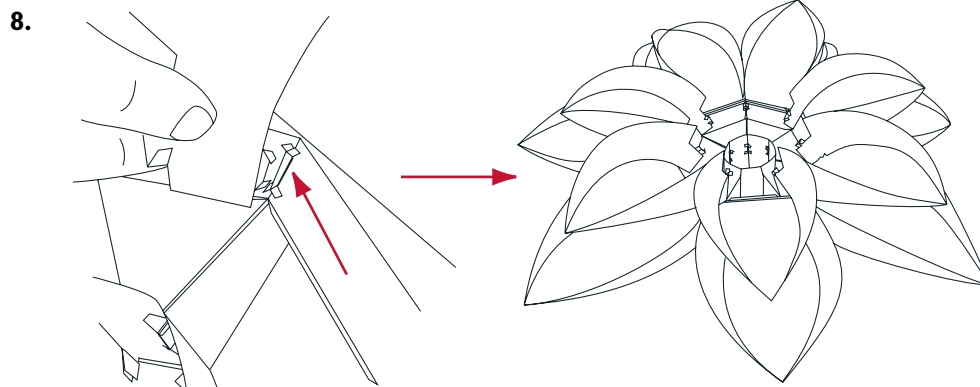

Pliez les 7 abats-jour comportant le chiffre '1'. Pliez soigneusement le long de la courbe de l'abat-jour. Montez le premier abat-jour sur l'anneau en insérant les rabats dans le trou où se trouvent les autres rabats.

Montez le reste des abats-jour en procédant de la même manière. Veillez à verrouiller les modules à l'arrière.

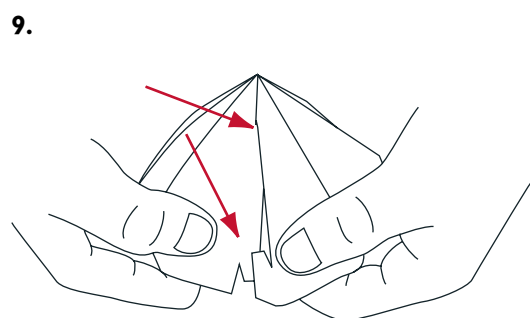

Pliez et assemblez le module de base. Assurez-vous que les joints sont tournés vers l'intérieur.

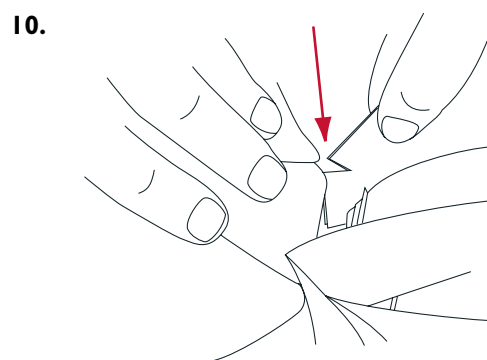

Fixez le module de base dans les fentes des abats-jour internes. (Les fentes sont de petites entailles).

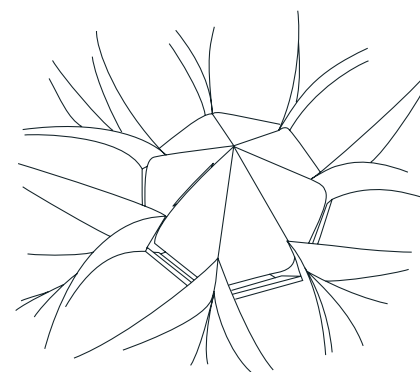

Le module de base assemblé.

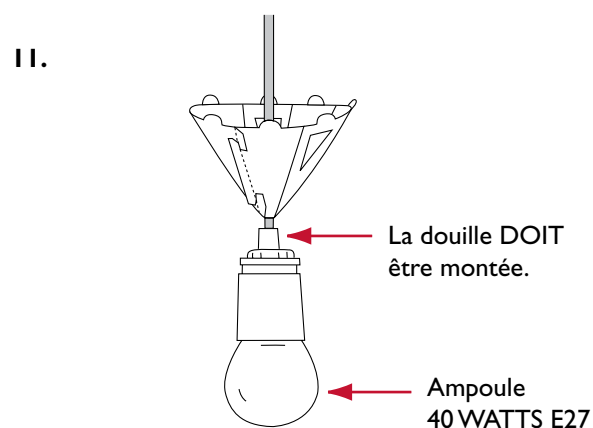

Pliez le module de suspension dans les 6 directions et assemblez autour du fil de façon à former un cône heptagonal.

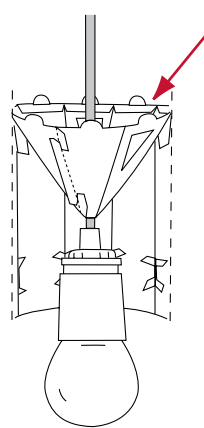

Tournez la lampe de façon à ce que l'ouverture au sommet de la lampe soit tournée vers le haut. Baissez le module de suspension dans l'ouverture et passez les rabats dans les trous. Rabaissez les bords renforcés horizontalement de façon à ce qu'ils soient fixés au module de suspension.

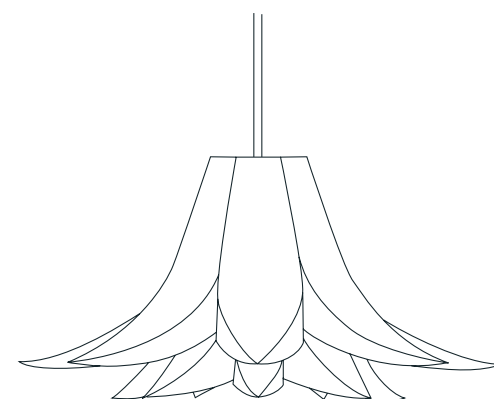

La lampe assemblée peut maintenant être accrochée. La lampe peut être accrochée sans retirer l'ampoule. Les ampoules peuvent être facilement remplacées grâce à la base flexible de la lampe.

MAX 40 WATTS

Contenido:

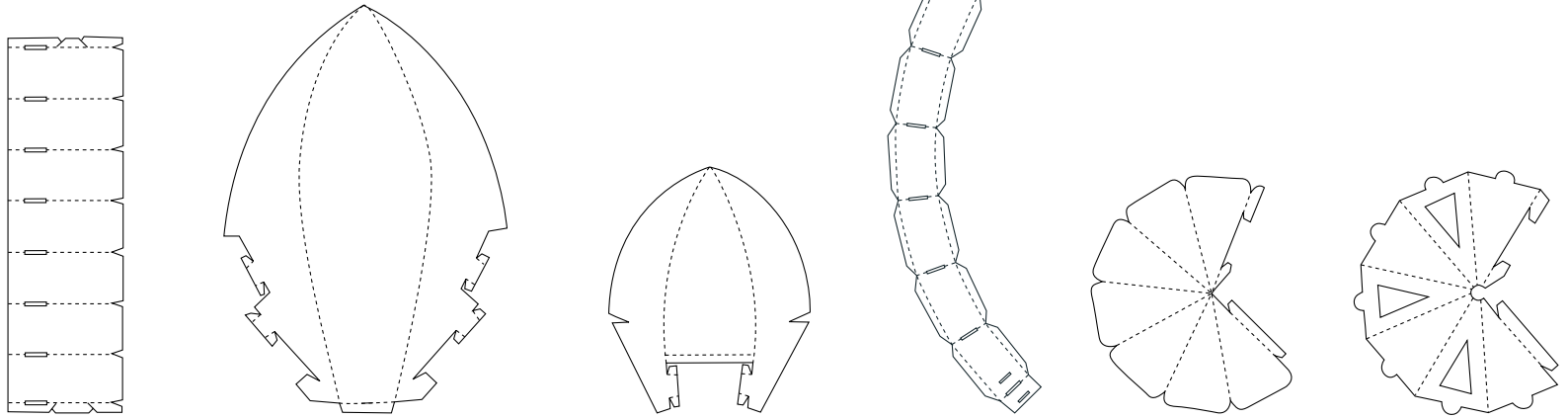

1 elemento de base

7 elementos de pantalla n.º 2

7 elementos de pantalla n.º 1

1 elemento circular pequeño S

1 módulo de base

1 módulo de suspensión

Instrucciones de montaje:

1.

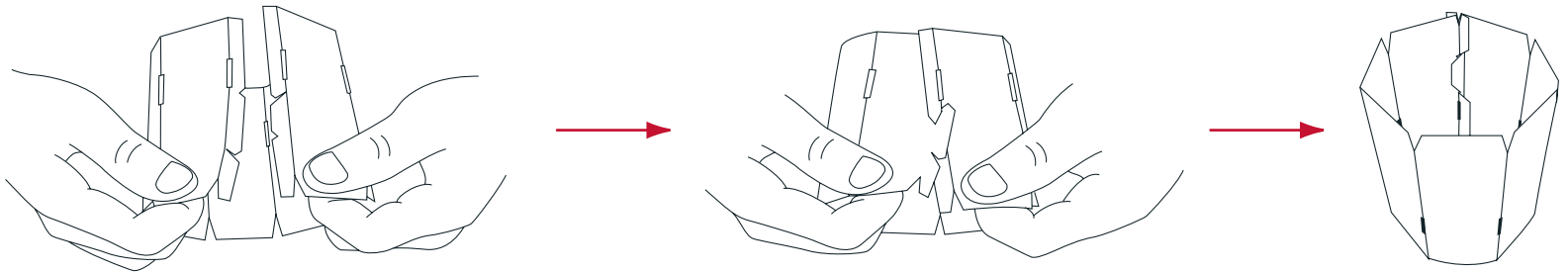

Cierre la base con el lado mate hacia afuera formando un cilindro de siete lados.

2.

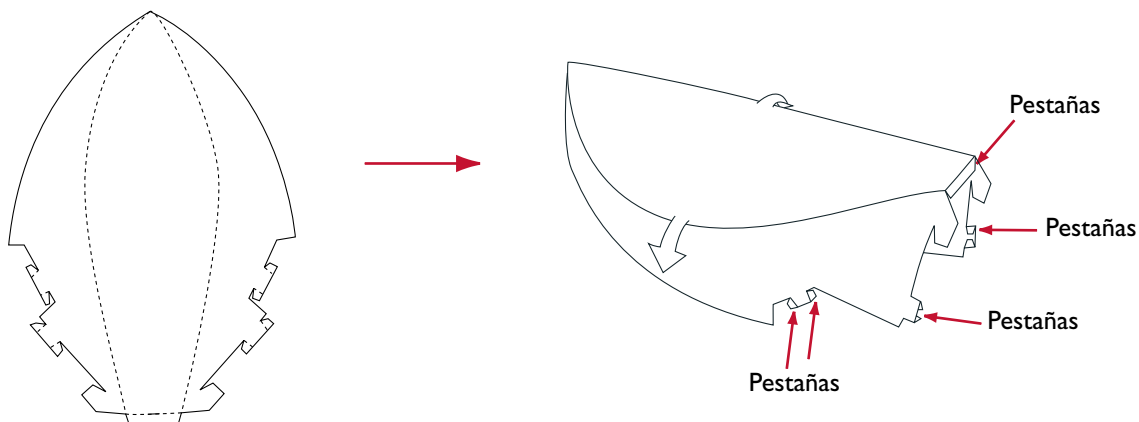

Pliegue los siete elementos de pantalla marcados con el número 2, como se muestra en la figura. Realice la operación con cuidado de seguir la curva del elemento de pantalla.

Doble las pestañas o lengüetas hacia adentro con el lado mate hacia afuera.

INSTRUCCIONES DE MONTAJE DE NORM 06 SMALL/ESPAÑOL

3.

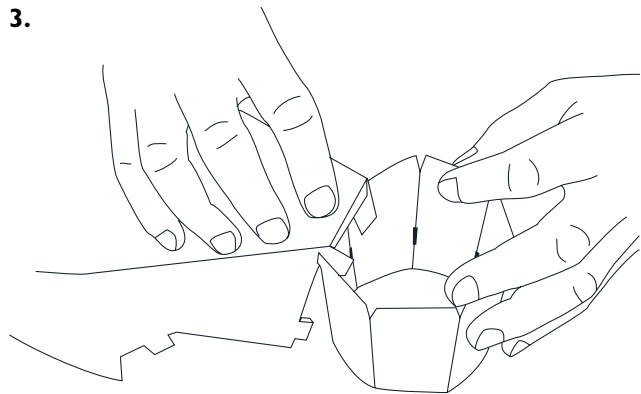

Enganche el elemento de pantalla a la parte estrecha de la abertura del elemento de base.

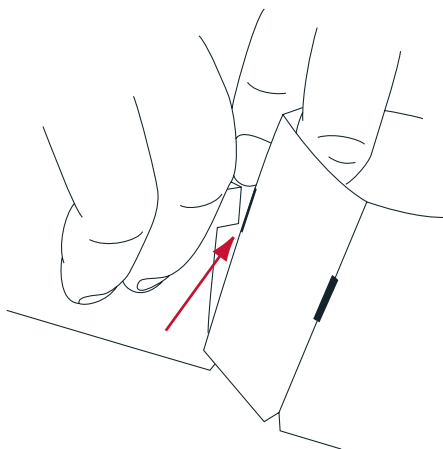

Ponga el elemento de base boca abajo, haga pasar las pestañas por los agujeros y dóblelas sobre la parte posterior para sujetar el módulo.

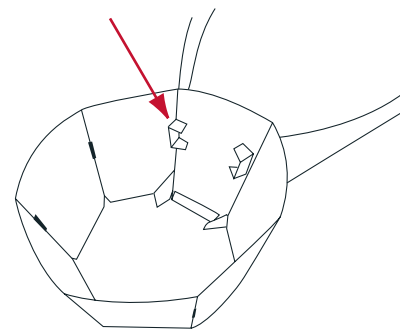

4.

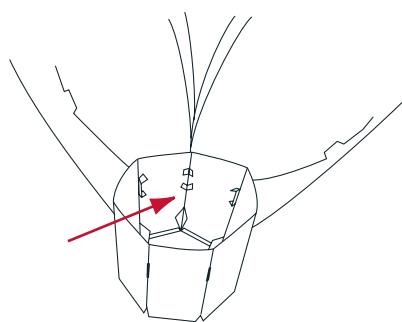

Coloque el siguiente elemento de la pantalla sobre la base, junto al primero, y continúe hasta haber montado los siete elementos marcados con el número 2. No olvide sujetar los módulos por el lado interior de la base.

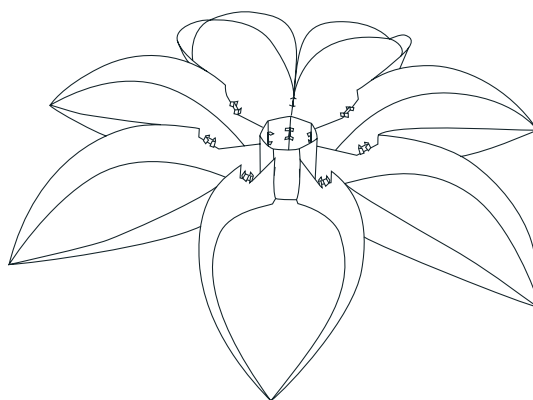

5.

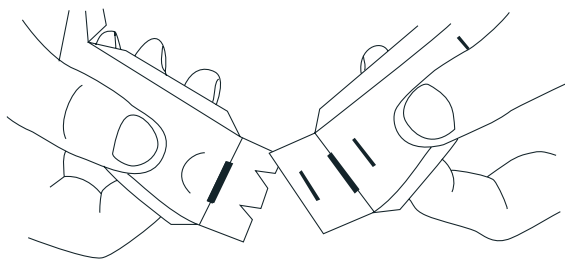

Sujete el elemento circular marcado como S y doble sobre sí mismos los bordes de refuerzo. Monte el elemento circular usando las pestañas.

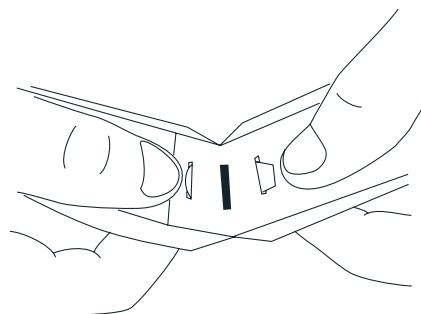

6.

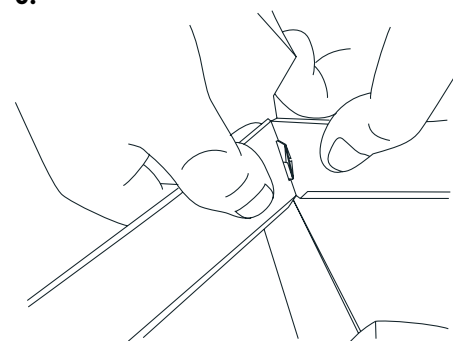

Monte el elemento circular S sobre las pestañas del elemento de pantalla y sujételos enderezando las pestañas.

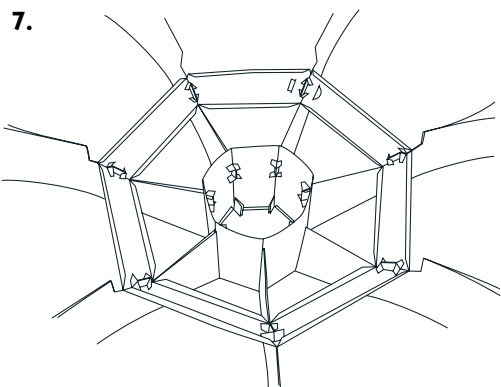

7. El elemento circular montado correctamente.

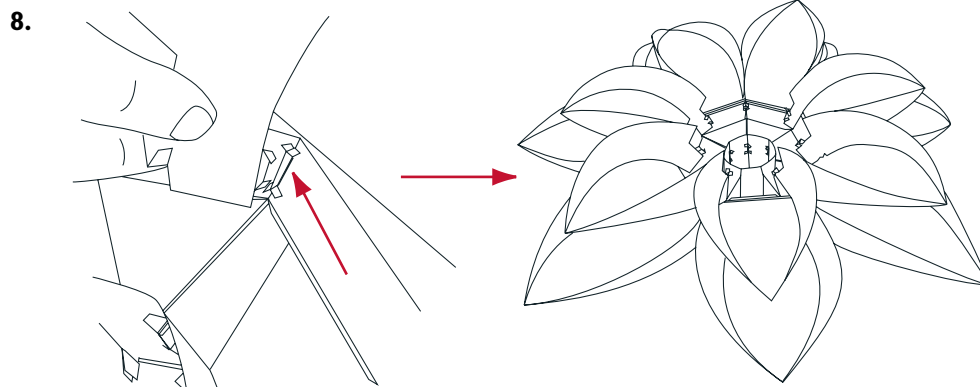

8. Pliegue los siete elementos de pantalla marcados con el número 1. Realice la operación con cuidado de seguir la curva del elemento de pantalla. Monte el primer elemento de la pantalla sobre el elemento circular haciendo pasar las pestañas por el agujero en el que también están las otras pestañas.

Monte el resto de los elementos de la pantalla a su alrededor. No olvide sujetar los módulos en la parte posterior.

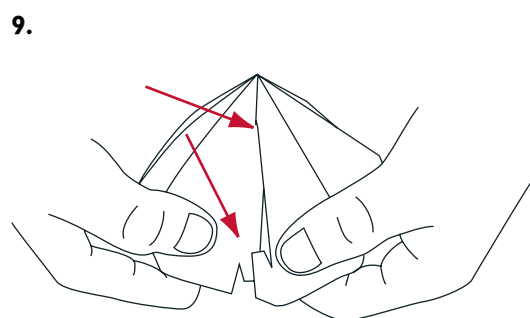

9. Doble y monte el módulo de base. Las uniones deben girarse hacia adentro.

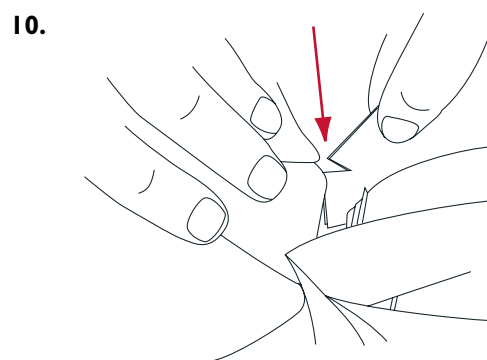

10. Coloque el módulo de base en las ranuras (cortes pequeños) de los elementos interiores de la pantalla.

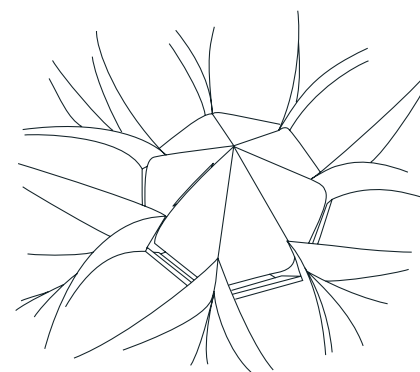

El módulo de base totalmente montado.

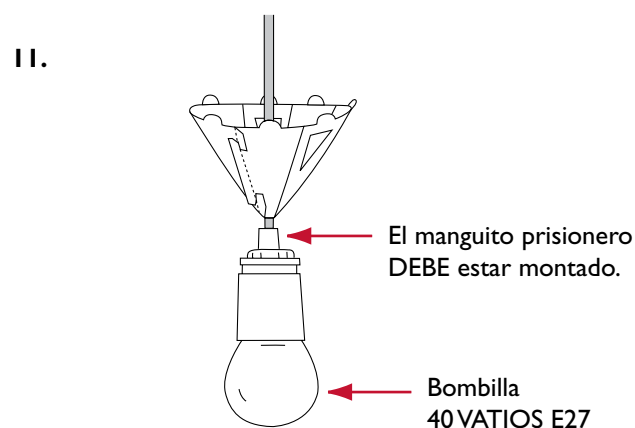

11. Pliegue el módulo de suspensión en las seis direcciones y móntelo alrededor de los alambres para formar un cono de siete lados.

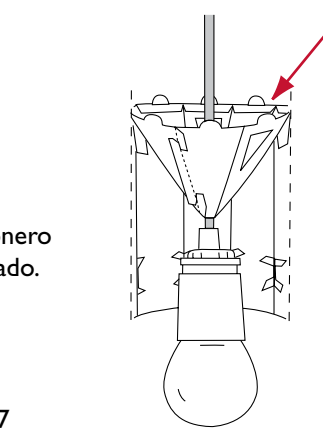

Dé la vuelta a la lámpara para que la abertura de la parte superior mire hacia arriba. Baje el módulo de suspensión por la abertura y empuje las pestañas por los agujeros. Vuelva los bordes de refuerzo en horizontal para que sujeten el módulo de suspensión.

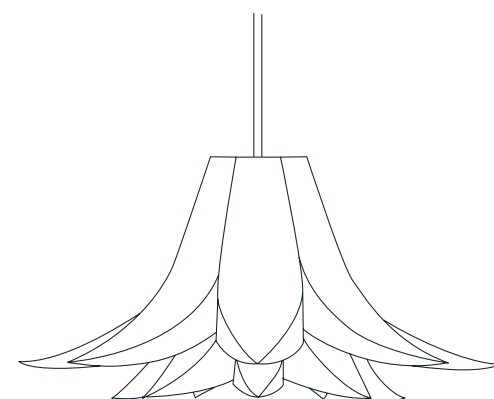

La lámpara terminada de montar, lista para colgarla. La lámpara puede colgarse sin necesidad de quitar el portalámparas. Las bombillas pueden cambiarse con facilidad a través de la base flexible de la lámpara.

MÁX 40 VATIOS

ISTRUZIONI DI MONTAGGIO NORM 06 SMALL/ITALIANO

Componenti:

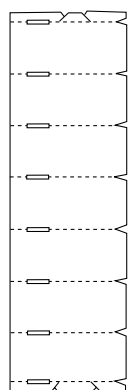

1 elemento base

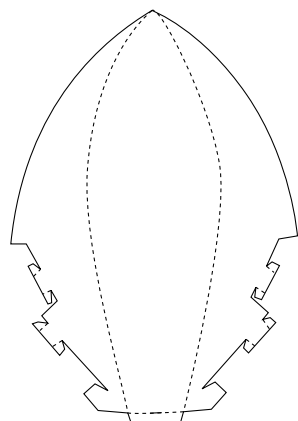

7 elementi paralume n. 2

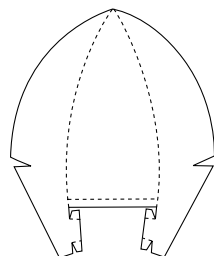

7 elementi paralume n. 1

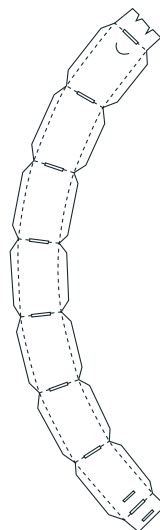

1 elemento ad anello S

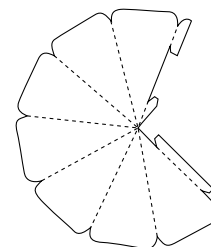

1 modulo base

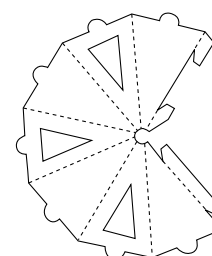

1 modulo di sospensione

Istruzioni di montaggio:

1.

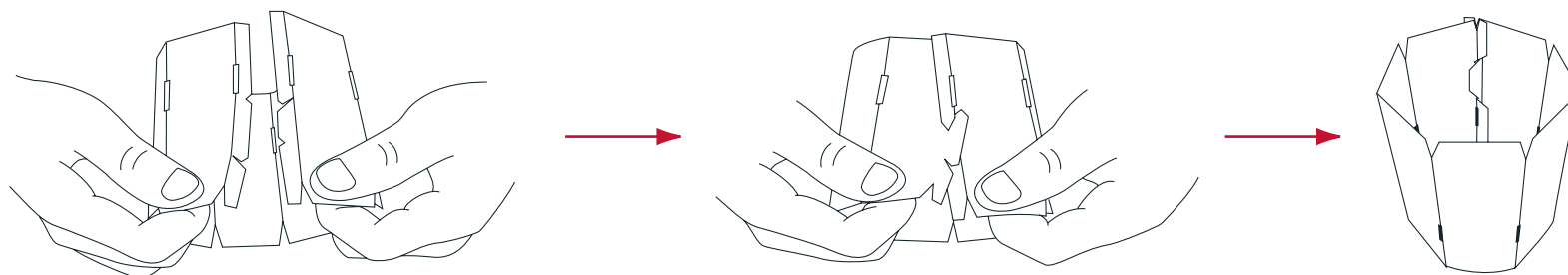

Assemblare la base formando un cilindro con sette lati e lasciando la superficie opaca all'esterno.

2.

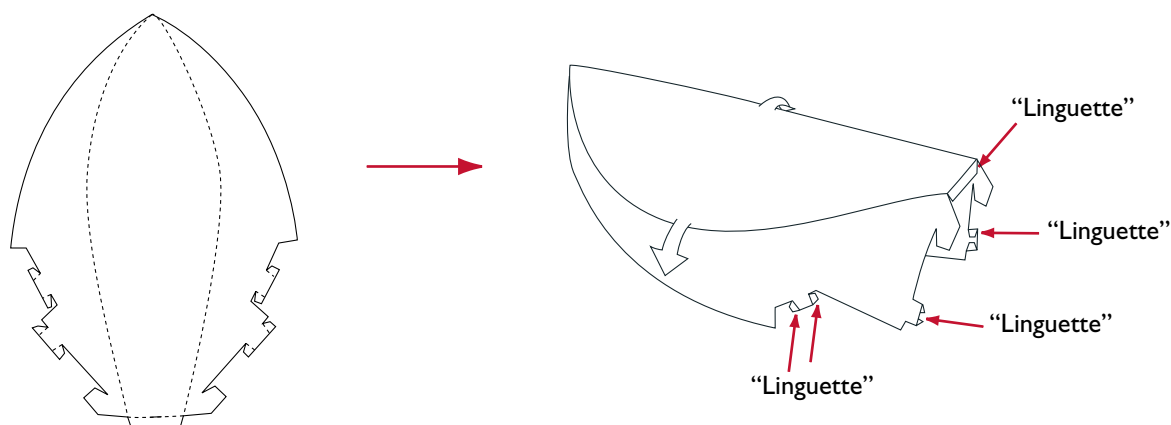

Piegare i 7 elementi paralume contraddistinti dal numero "2" come mostrato in figura. Piegare con cura il lato curvo dell'elemento paralume.

Piegare le "linguette" all'interno lasciando il lato opaco all'esterno.

3.

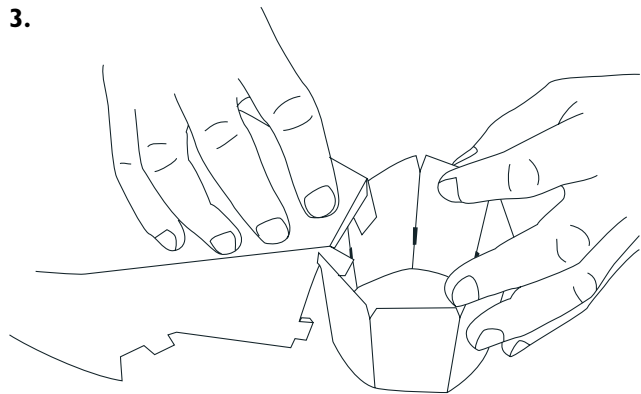

Fissare l'elemento paralume al lato stretto dell'apertura dell'elemento base.

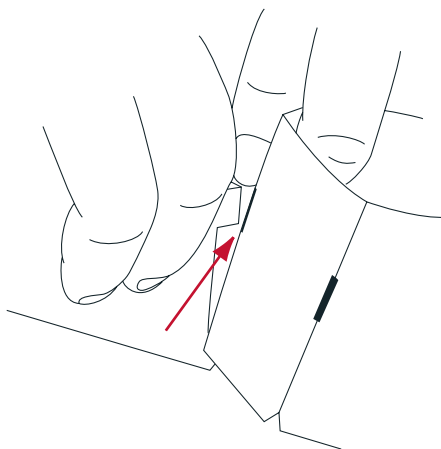

Capovolgere l'elemento base e guidare le "linguette" all'interno delle fessure, piegandole poi sul retro per fissare il modulo.

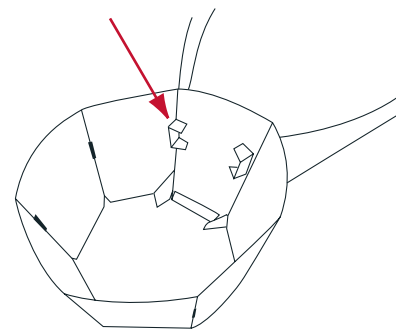

4.

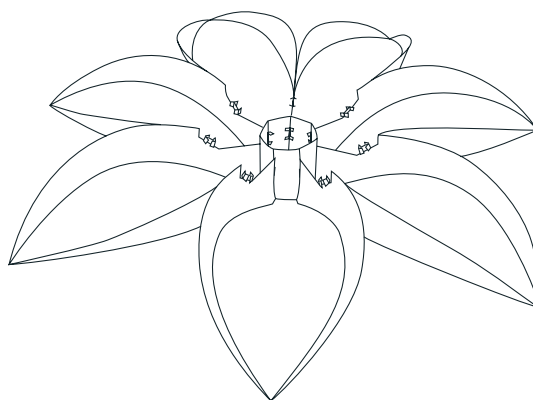
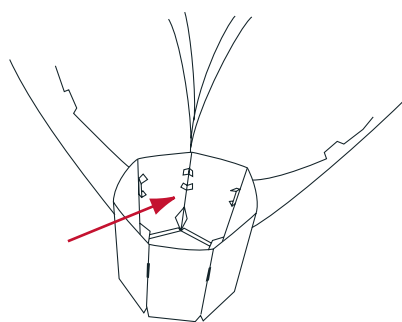

Appoggiare un altro elemento paralume alla base, accanto al primo. Quindi procedere nello stesso modo al montaggio del resto dei 7 elementi paralume "2". Non dimenticare di fissare i moduli all'interno della base.

5.

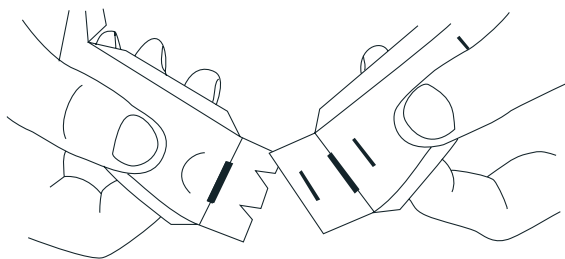

Prendere l'elemento ad anello contraddistinto dalla lettera "S" e piegare i bordi di rinforzo. Montare l'elemento ad anello servendosi delle "linguette".

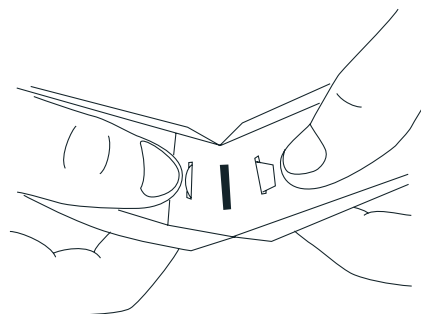

6.

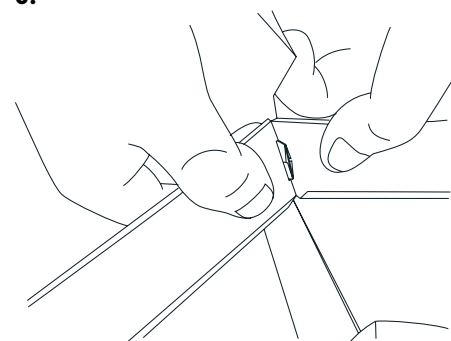

Inserire l'elemento ad anello "S" all'interno delle "linguette" dell'elemento paralume e fissare le "linguette" raddrizzandole.

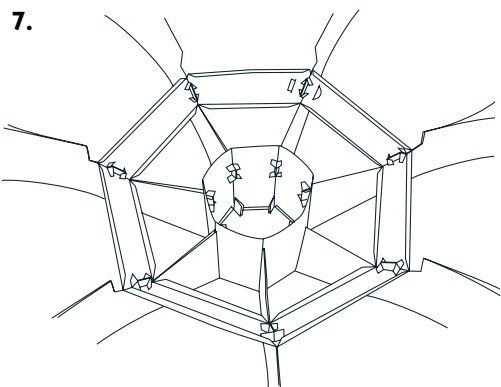

7. Elemento ad anello correttamente montato.

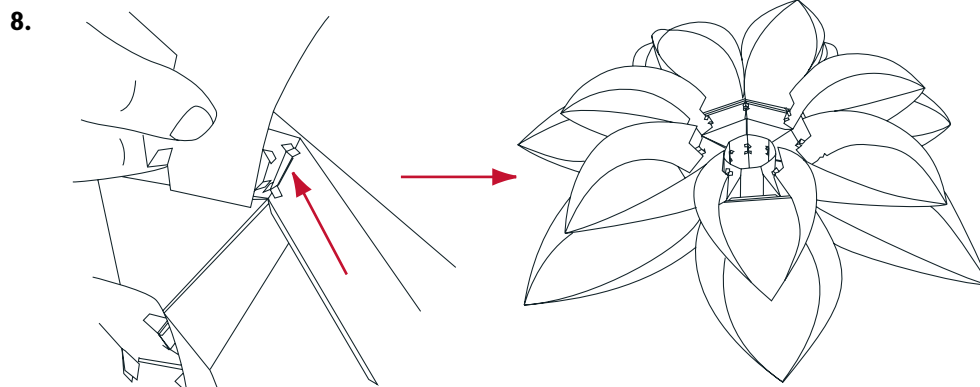

8. Piegare i 7 elementi paralume contraddistinti dal numero "1". Piegare con cura il lato curvo dell'elemento paralume. Fissare il primo elemento paralume all'elemento ad anello spingendo le "linguette" attraverso la fessura in cui sono state inserite le altre.

Montare il resto degli elementi paralume tutt'intorno nello stesso modo. Non dimenticare di fissare i moduli sul retro.

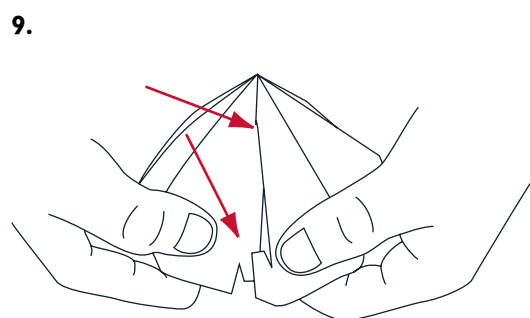

9. Curvare e assemblare il modulo base. Assicurarsi che le giunture siano rivolte verso l'interno.

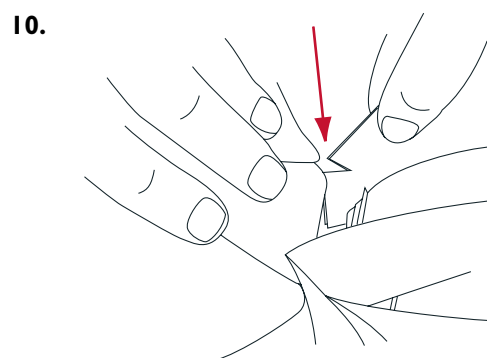

10. Inserire il modulo base all'interno delle scanalature degli elementi paralume interni. (Le scanalature sono i piccoli tagli).

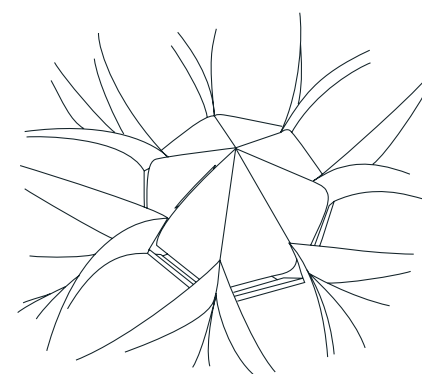

Modulo base completamente montato.

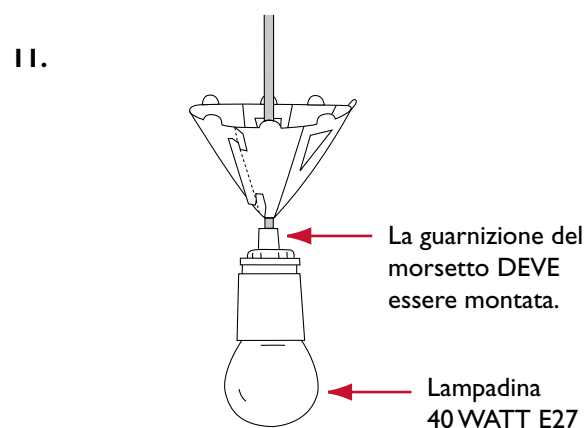

11. Piegare il modulo di sospensione nelle sei direzioni e assemblarlo intorno ai fili formando un cono con 7 lati.

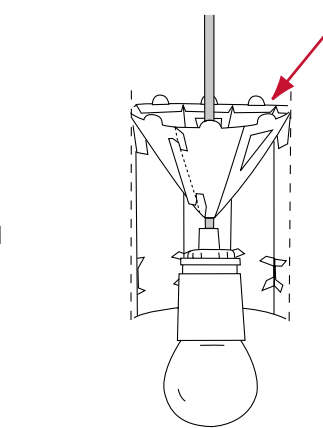

Ruotare il lampadario in modo tale che l'apertura alla sommità dello stesso sia rivolta verso l'alto. Abbassare il modulo di sospensione all'interno dell'apertura e spingere le "linguette" all'interno delle fessure. Piegare orizzontalmente i bordi di rinforzo così da fissare il modulo di sospensione.

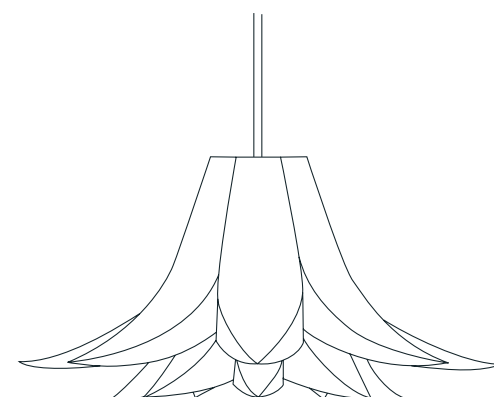

Lampadario completamente montato e pronto per essere appeso. Il lampadario può essere appeso senza necessità di rimuovere il portalampada. Le lampadine possono essere facilmente sostituite tramite la base flessibile del lampadario.

MAX 40 WATT

Inhoud:

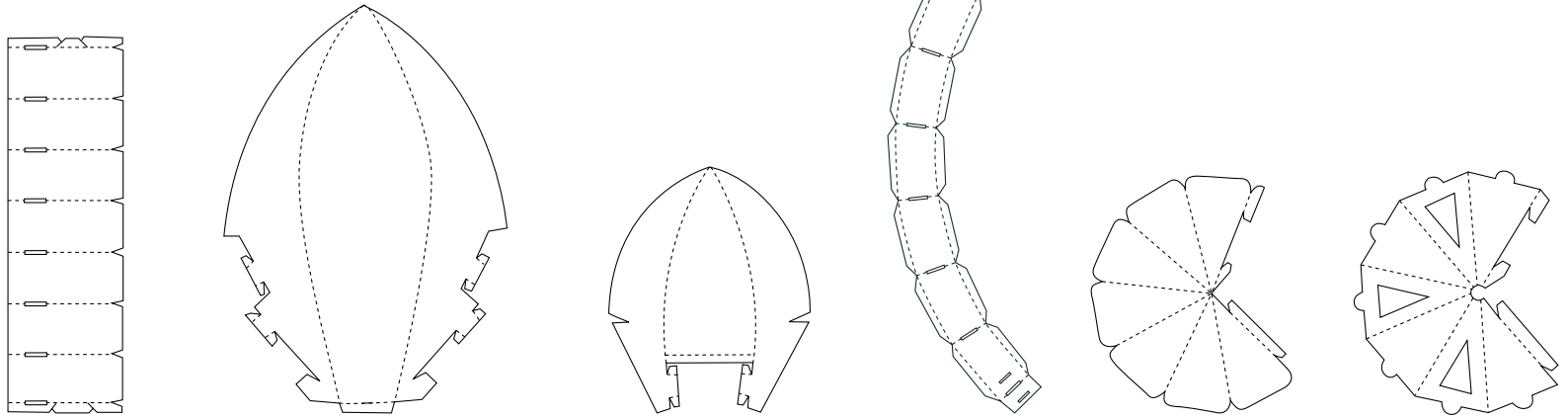

1 basiselement

7 lampenkap-elementen
nr. 2

7 lampenkap-elementen
nr. 1

1 ringelement S

1 basismodule

1 hangmodule

Montage-instructies:

1.

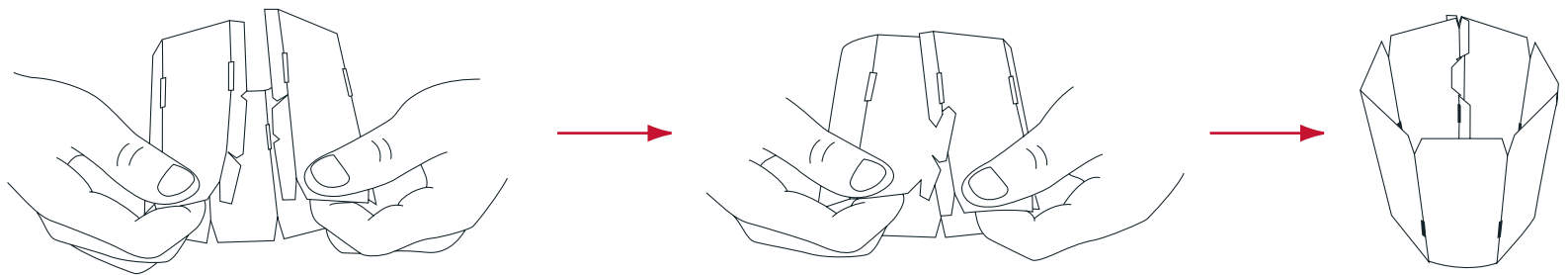

Klik het basiselement met de matte kant naar buiten in elkaar als een zevenkantige cilinder.

2.

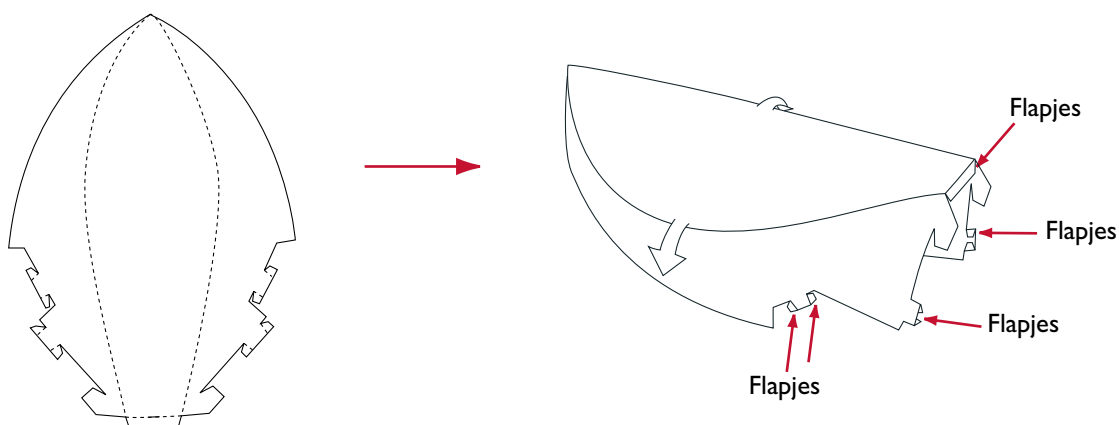

Vouw de 7 lampenkap-elementen met de markering 2 zoals aangegeven. Vouw zorgvuldig langs de kromming van het kap-element.

Vouw de flapjes naar binnen met de matte kant naar buiten.

MONTAGE-INSTRUCTIES NORM 06 SMALL/NEDERLANDS

3.

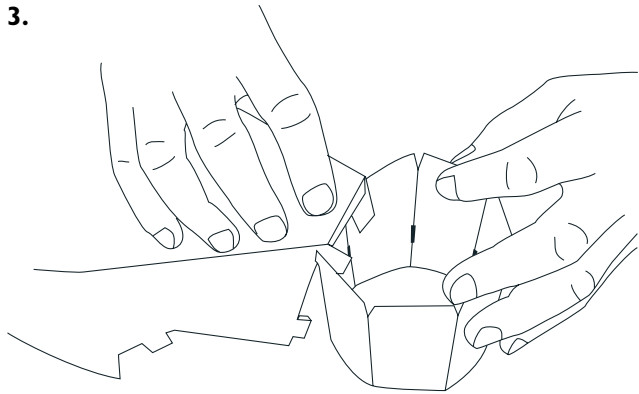

Hang het kap-element op de smalle kant van de opening van het basiselement.

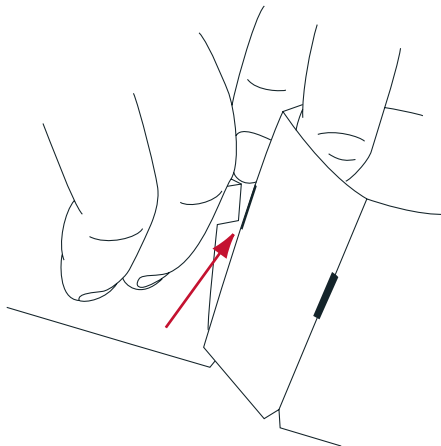

Draai het basiselement om en plaats de flapjes door de openingen. Vouw ze aan de achterkant om om de module vast te zetten.

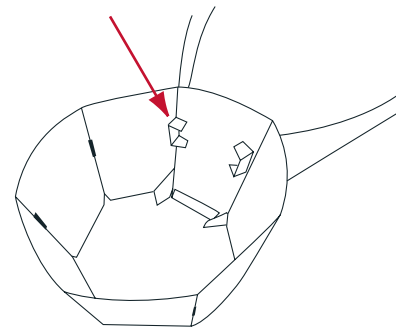

4.

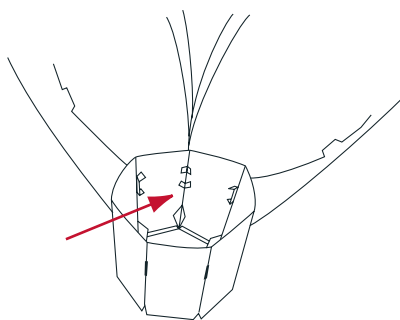

Plaats het volgende kap-element naast het eerste kap-element op het basiselement en ga zo door totdat alle 7 lampenkap-elementen met de markering 2 zijn geplaatst. Zet de modules aan de binnenkant van het basiselement vast.

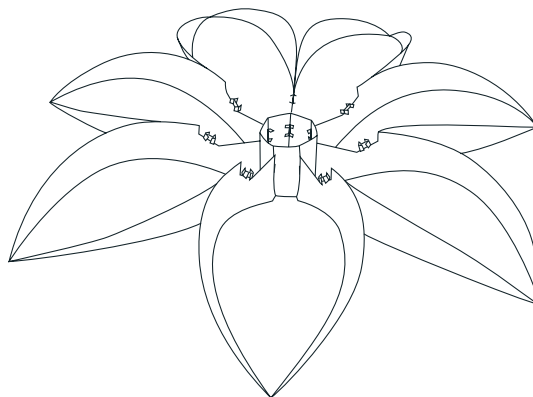

5.

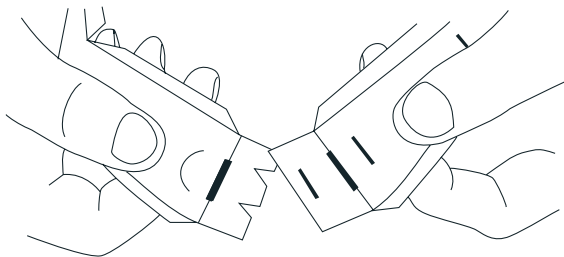

Neem het ringelement met de markering S en vouw de verstevigingsranden om. Zet het ringelement met behulp van de flapjes in elkaar.

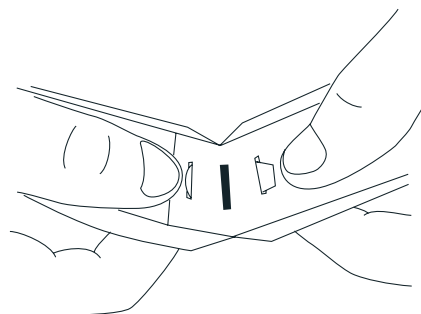

6.

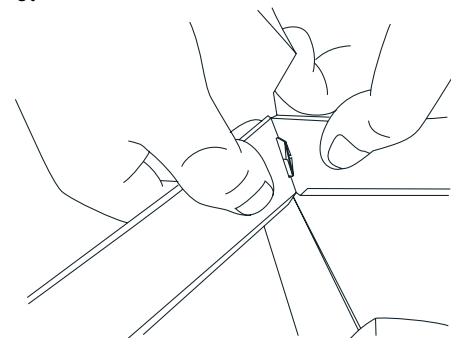

Bevestig ringelement S op de flapjes van het lampenkap-element en zet ze vast door de flapjes recht te buigen.

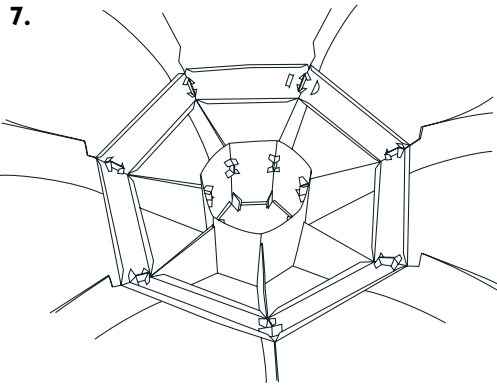

Het correct bevestigde ringelement.

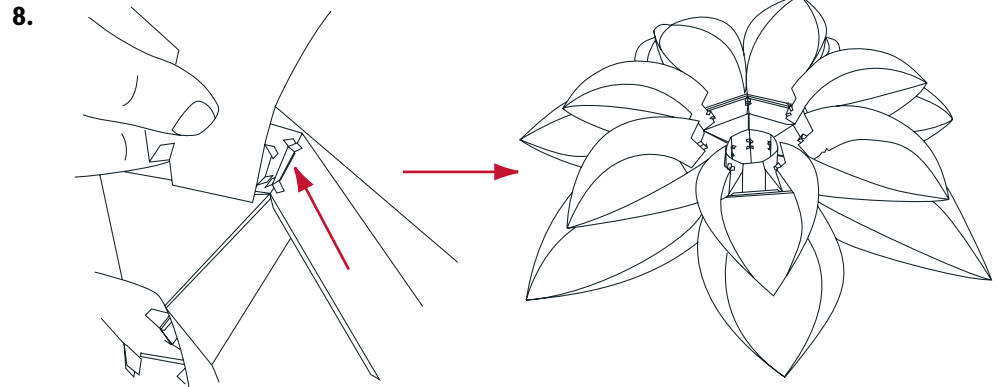

Vouw de 7 lampenkap-elementen met de marking 1. Vouw zorgvuldig langs de kromming van het kap-element. Bevestig het eerste kap-element aan het ringelement door de flapjes door de opening te duwen waar zich ook de andere flapjes bevinden.

Bevestig op dezelfde manier de andere lampenkap-elementen. Vergeet niet de modules aan de achterkant vast te zetten.

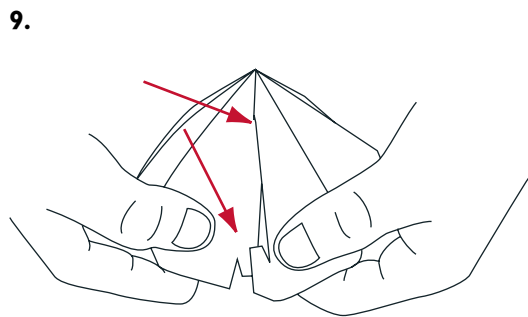

Buig de basismodule om en zet deze in elkaar met de bevestigingspunten naar binnen.

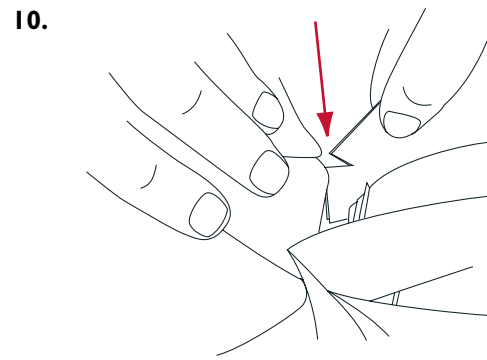

Plaats de basismodule in de sleuven in de binnenste lampenkap-elementen (de sleuven zijn kleine inkepingen).

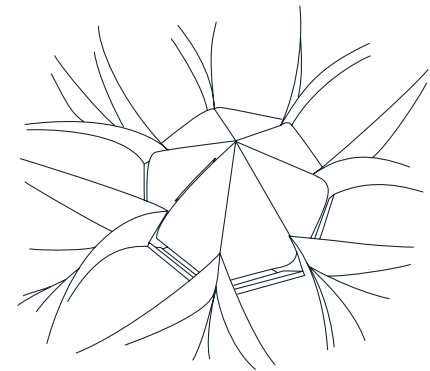

De volledig gemonteerde basismodule.

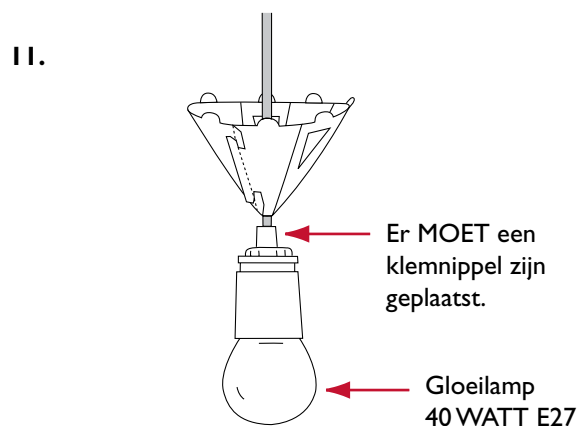

Buig de hangmodule in de zes richtingen en plaats deze als een zevenkantige kegel aan het snoer.

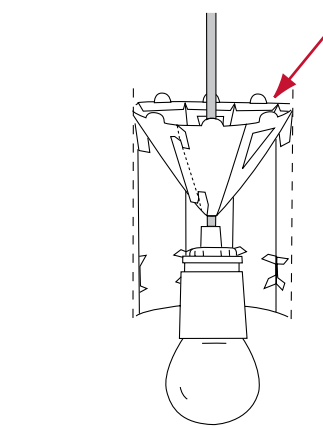

Draai de lamp om zodat de opening aan de bovenkant van de lamp naar boven wijst. Laat de hangmodule in de opening zakken en duw de flapjes door de gaten. Buig de verstevigungsranden horizontaal omlaag om de hangmodule vast te zetten.

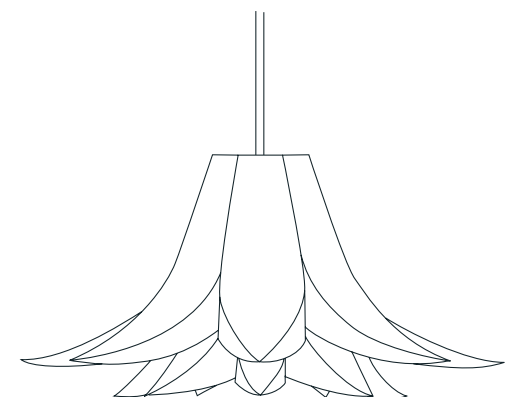

De volledig gemonteerde lamp, klaar om op te hangen. U hoeft de lampfitting niet te verwijderen om de lamp op te hangen. De gloeilamp is eenvoudig te verwisselen via de flexibele onderkant van de lamp.

MAX 40 WATT

INSTRUÇÕES DE MONTAGEM NORM 06 SMALL/PORTUGUÊS

Componentes:

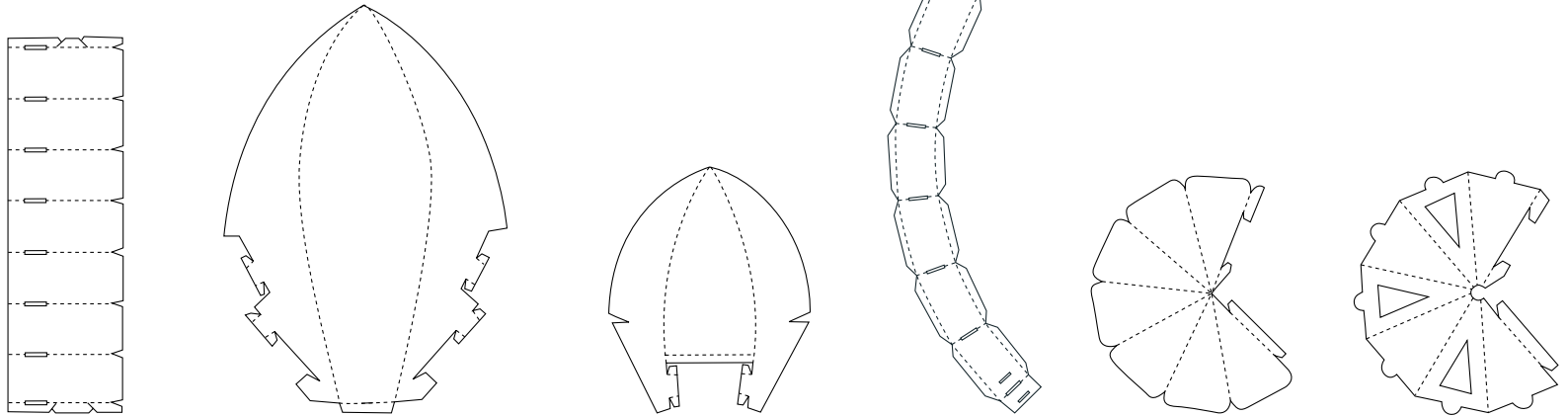

1 elemento base

7 elementos do abajur n.º 2

7 elementos do abajur n.º 1

1 elemento do anel S

1 módulo base

1 módulo de suspensão

Instruções de montagem:

1.

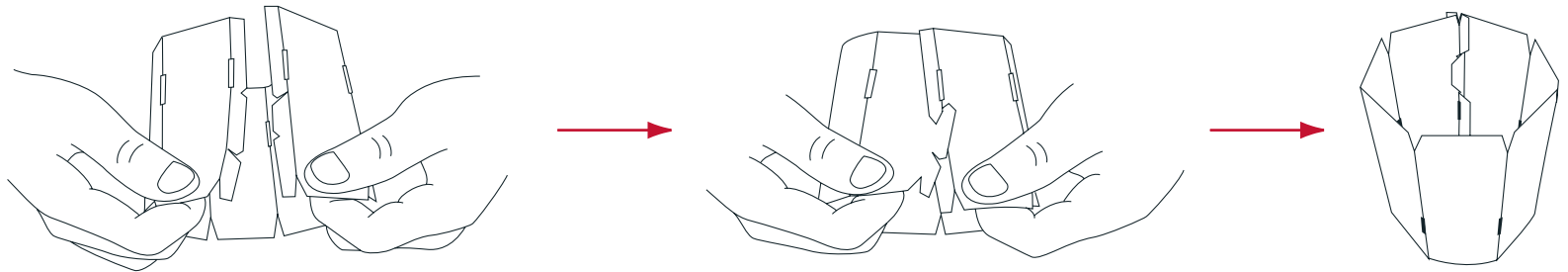

“Dobre” a base num cilindro com 7 lados, com a parte mate para fora.

2.

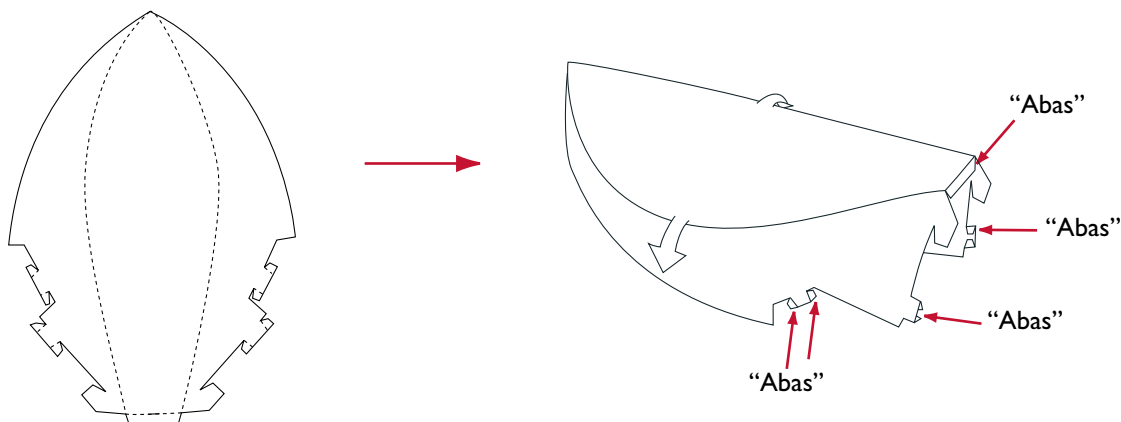

Dobre os 7 elementos do abajur assinalados como “2” conforme se ilustra. Dobre cuidadosamente ao longo do elemento do abajur.

Dobre as “abas” para dentro, com o lado mate para fora.

3.



Engate o elemento do abajur na parte estreita da abertura no elemento base.

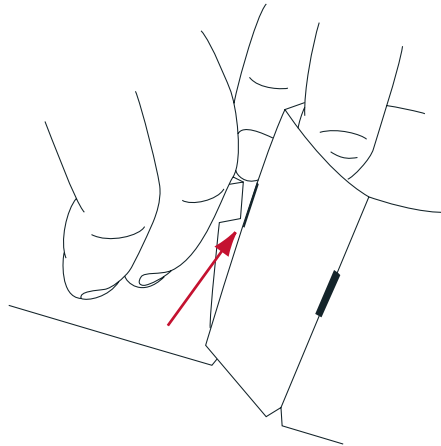

Vire o elemento base ao contrário e insira as "abas" nos orifícios, dobrando-as na parte de trás para apertar o módulo.

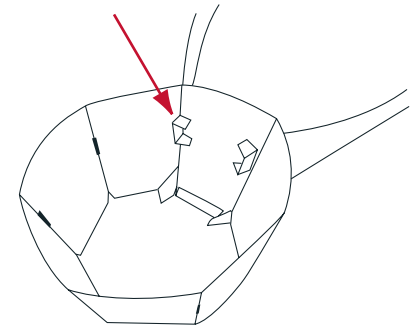

4.

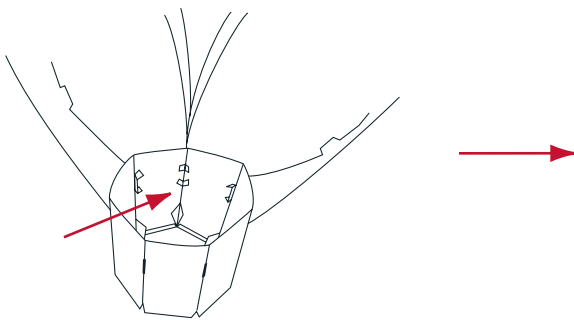

Coloque o elemento seguinte do abajur na base, junto ao primeiro, e continue até que todos os 7 elementos do abajur assinalados como n.º 2 estejam montados. Lembre-se de apertar os módulos no interior da base.

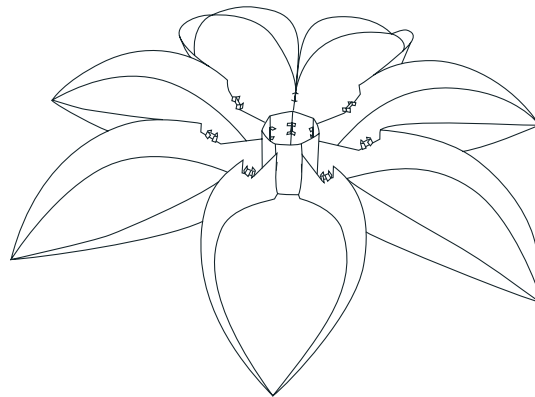

5.

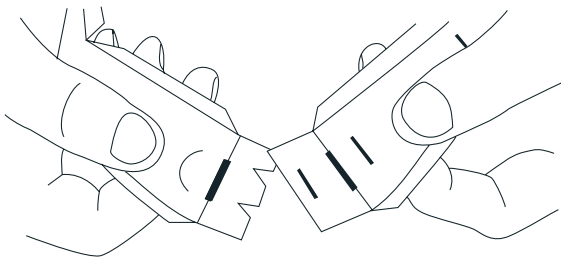

Pegue no elemento do anel assinalado como "S" e dobre as extremidades uma sobre a outra. Instale o elemento do anel usando as "abas".

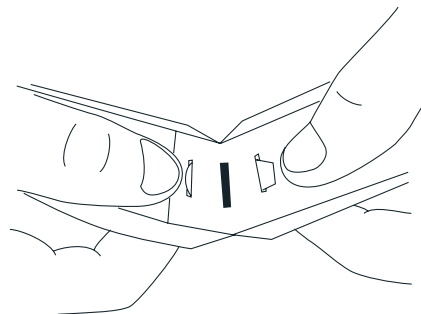

6.

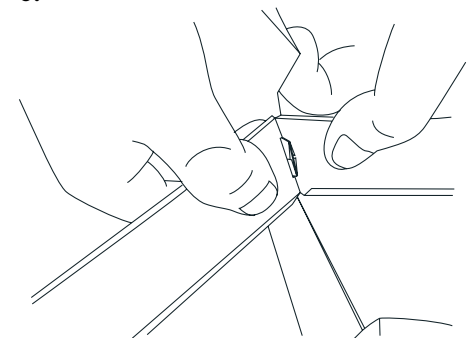

Insira o elemento do anel "S" nas "abas" do elemento de abajur e aperte-os endireitando as "abas".

INSTRUÇÕES DE MONTAGEM NORM 06 SMALL/PORTUGUÊS

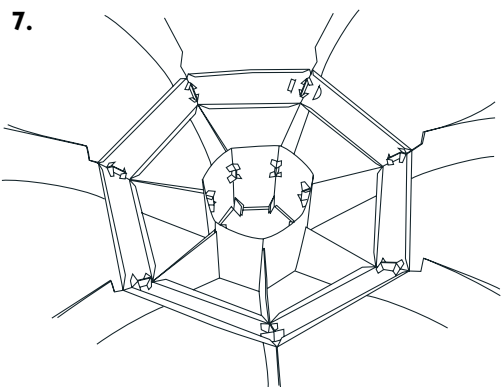

Elemento do anel correctamente montado.

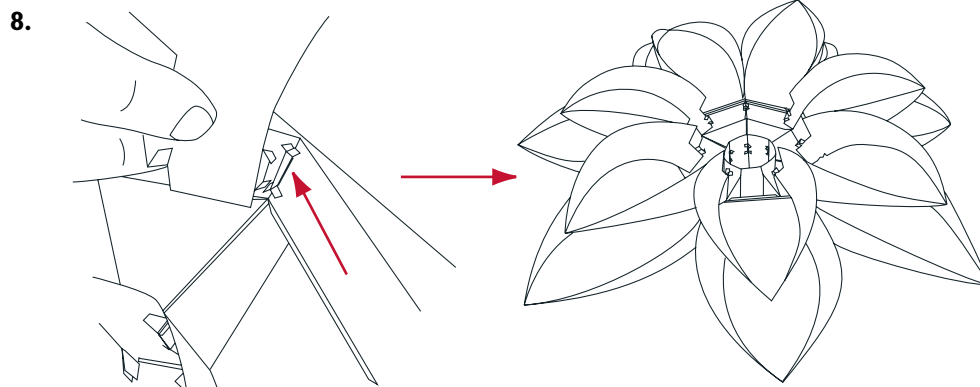

Dobre os 7 elementos do abajur assinalados como "1". Dobre cuidadosamente sobre a curva do elemento do abajur. Coloque o primeiro elemento do abajur sobre o elemento do anel inserindo as "abas" no orifício em que se encontram as outras "abas".

Monte de forma idêntica os restantes elementos do abajur a toda a volta. Não se esqueça de prender os módulos na parte de trás.

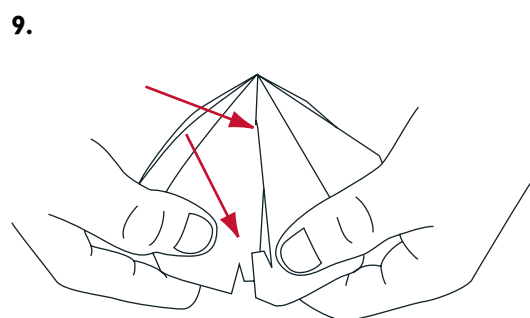

Curve e instale o módulo base. Verifique se as juntas estão viradas para dentro.

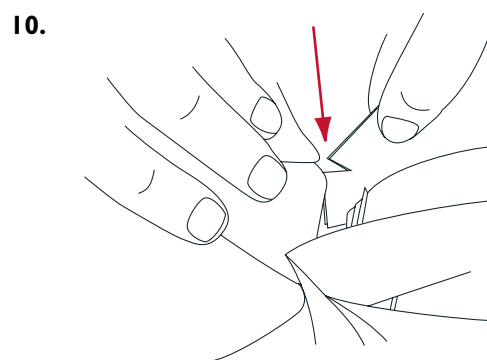

Insira o módulo base nas ranhuras dos elementos internos do abajur. (As ranhuras são os pequenos cortes).

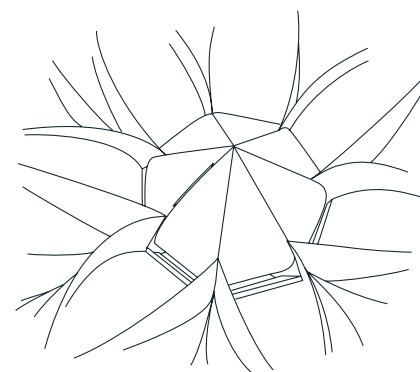

O módulo base totalmente montado.

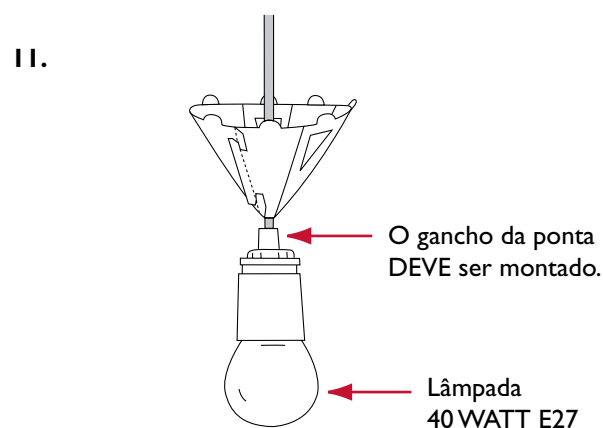

Dobre o módulo de suspensão nas 6 partes e instale-o à volta dos fios para formar um cone com 7 lados.

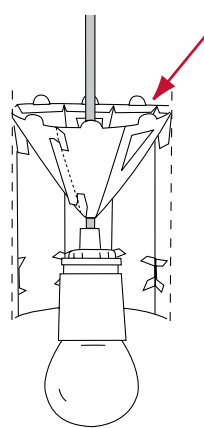

Rode o candeeiro para que a abertura na parte de cima fique virada para cima. Desça o módulo de suspensão e insira as "abas" nos orifícios. Posicione as extremidades horizontalmente para apertarem o módulo de suspensão.

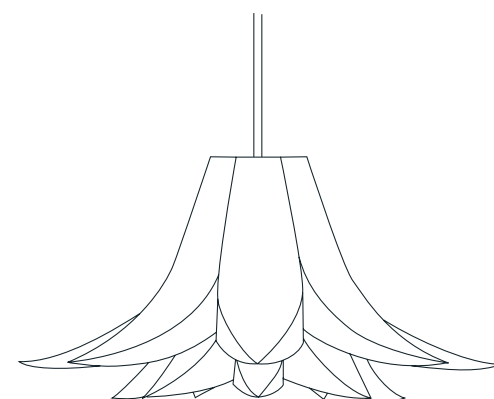

O candeeiro totalmente instalado e pronto para ser suspenso. O candeeiro pode ser suspenso sem retirar a ligação eléctrica. As lâmpadas podem ser trocadas facilmente através da base flexível do candeeiro.

MAX 40 WATT

内容:

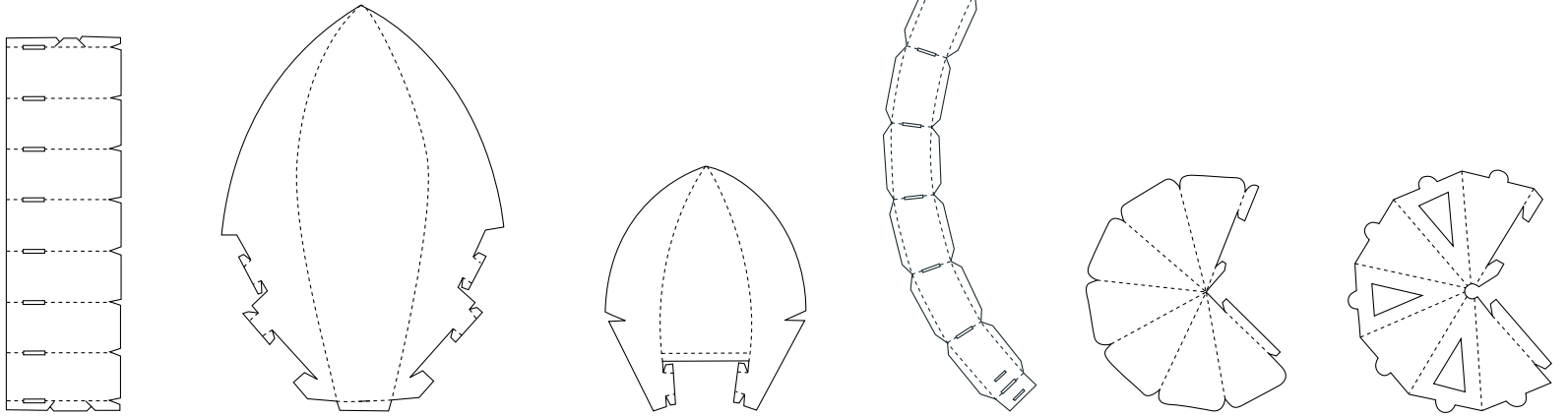

ベース エレメント 1 個

ランプシェード エレメント (no. 2) 7 個

ランプシェード エレメント (no. 1) 7 個

リング エレメント S 1 個

ベース モジュール 1 個

サスペンション モジュール 1 個

組み立て方:

1.

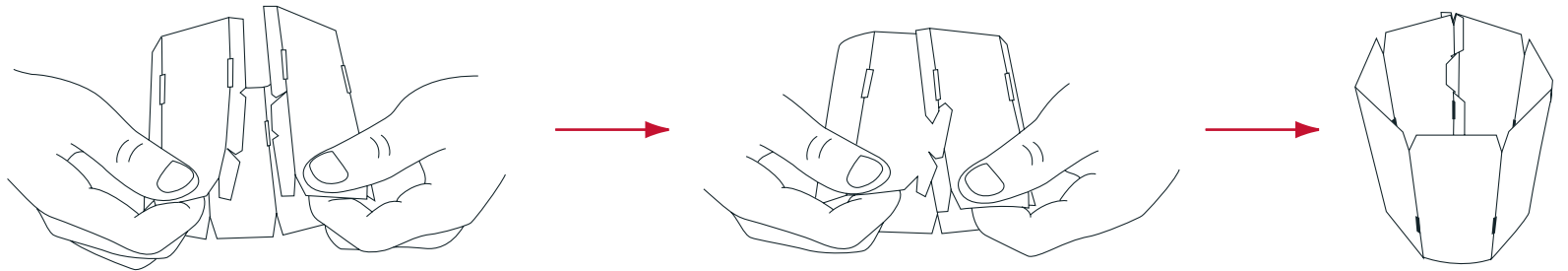

マット面を外側にして、ベースエレメントを「パチッ」と音がするまではめ込みます。

- ❗ 使用中に異臭や異常が感じられた場合、すぐに使用をやめ、電球が本体に接触していないか確認してください。
- ・電球の交換は電源を切ってから行ってください。
- ・つりさげた状態で、本体を揺らしたり持ち上げたりしないでください。
- ・本製品はプラスチックシートでできているため、使用頻度や年月により硬化しますので、折り曲げ部分が弱くなる場合があります。
- ・白熱球をご使用になりますと、土台部分に熱を持ち、パーツが変形したり火災の原因となります。危険ですので、必ず **E26口金13W以下の蛍光灯** をご使用ください。上記以外の電球を使用時に起きた不具合につきましては、対応いたしかねますので、予めご了承ください。

2.

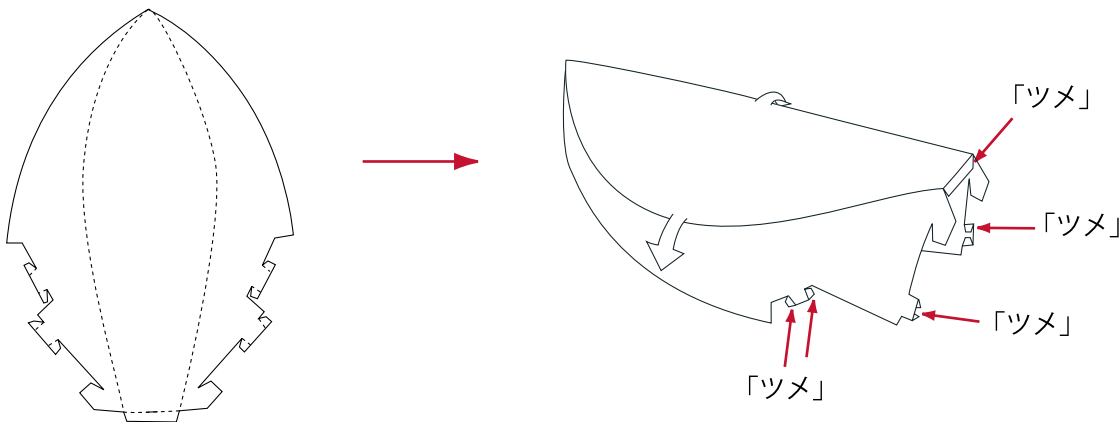

ランプシェード エレメント (no. 2) 7 個を折ります。シェードエレメントの形に合わせて折ってください。

マット面を外側にして、図の様に「ツメ」の部分の折り返します。

組み立て方 NORM 06 SMALL / 日本語

3.



シェード エレメントを、ベース
エレメントの狭い方の開口部にひっか
けます。

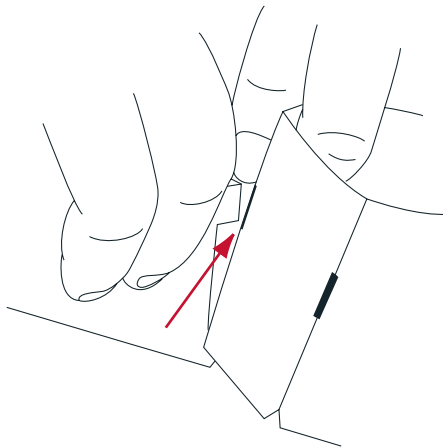

ベース エレメントを上下逆さにして、
「ツメ」を穴に通して裏側で折り、モジ
ュールを固定します。

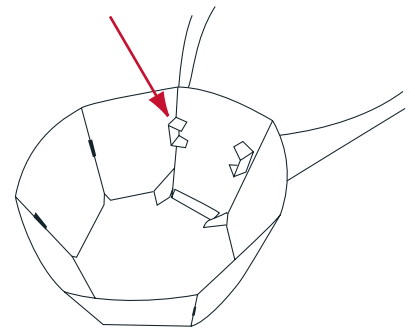

4.

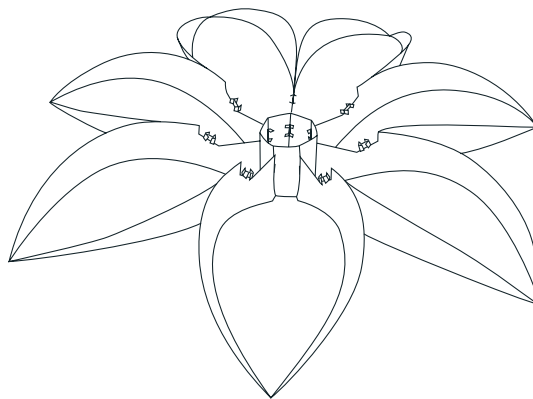
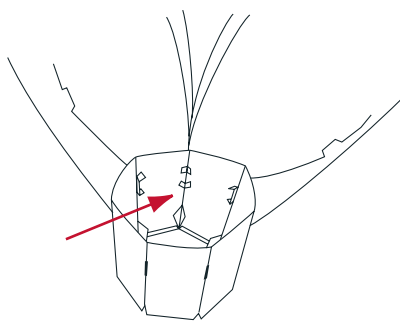

次のシェード エレメントをベースに
置いて、同じ手順を繰り返します。
ランプシェード エレメント (no.2) 7
個をすべて取り付けます。モジュールは、
必ずベースの内側で固定してください。

5.

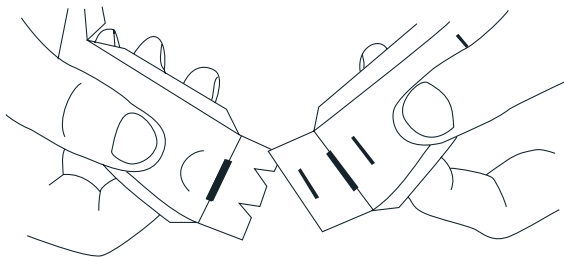

リングエレメント(S)の両端を折り、
ツメを差し込みリングエレメントを
組み立てます。

6.

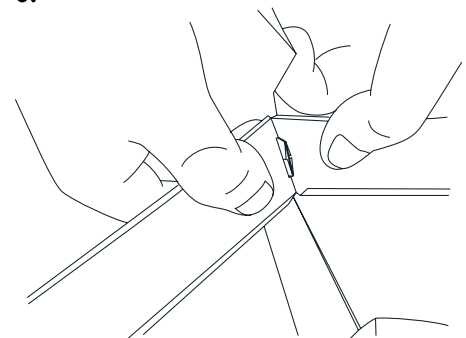

リングエレメント(S)をランプシェードエレ
メントの「ツメ」に合わせ、折り返した
「ツメ」をまっすぐに開いて固定します。

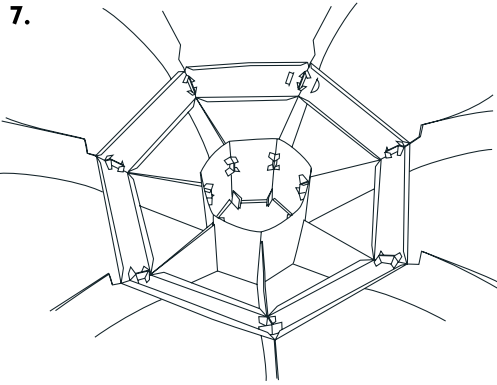

7.
リング エLEMENT が正しく取り付けられた状態。

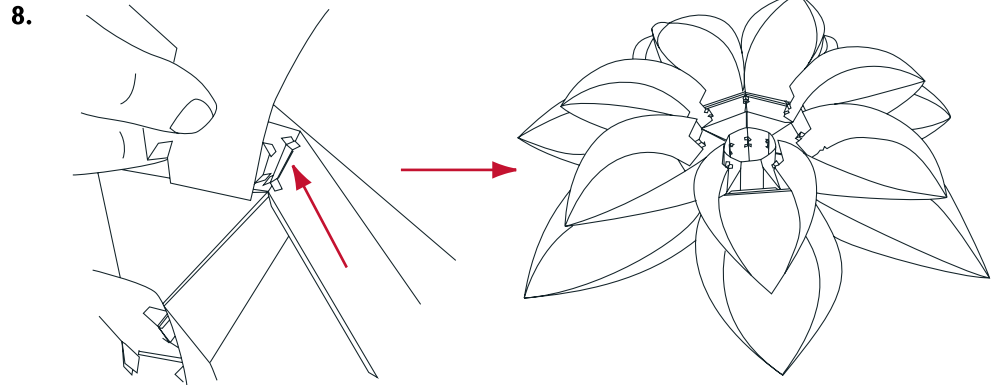

8.
ランプシェードELEMENT (no. 1) 7つを折ります。シェードELEMENTの形にそって折って下さい。シェードELEMENTをリングELEMENTに置き、一方の「ツメ」をもう一方の「ツメ」がある穴に通します。

同じように、残りのランプシェードELEMENTを取り付けます。モジュールは、必ず裏側で固定してください。

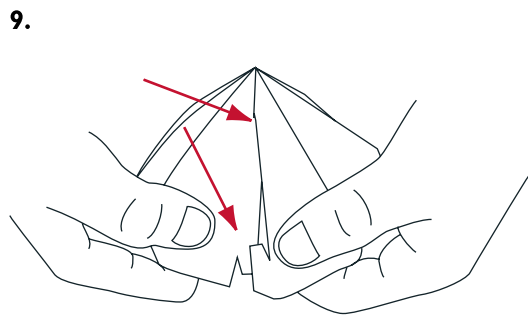

9.
ベースモジュールを折り、ツメが内側になるように組み立てます。

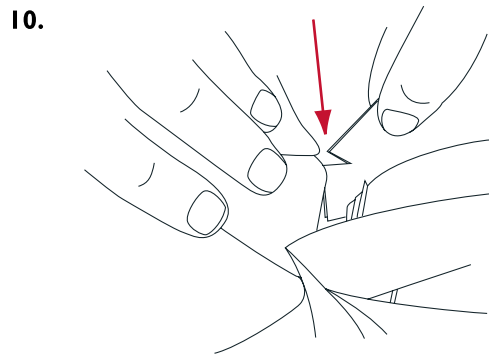

10.
ベースモジュールを、ランプシェードELEMENT内側にある切れ目にはめ込みます。(切れ目は小さな切り込みです)。

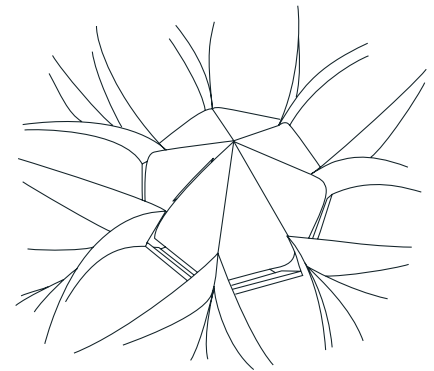

ベースモジュールを完全に組み立てます。

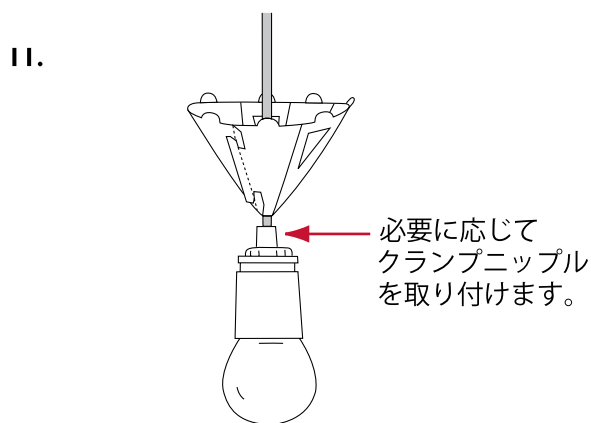

11.
サスペンションモジュールを折り、コードに取り付け、図のようにツメを組み合せて。モジュールは7面の円すい状になります。

組み上がったランプシェード上部の開口部を上向きにします。サスペンションモジュールを開口部から下げ入れ、丸形のツメを穴に通します。図の矢印が指している部分のように端部のツメを内側に折り、サスペンションモジュールを固定します。

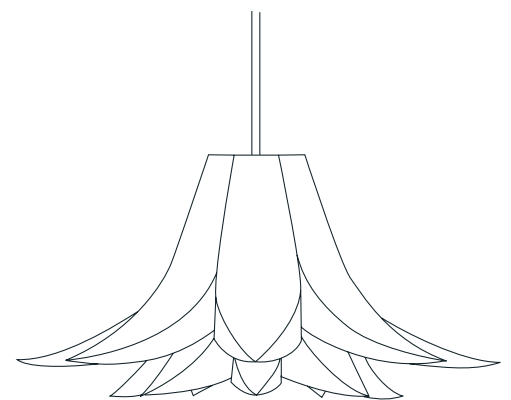

組み立ては終了です。電球はベースモジュールを取り外すことによって簡単に交換出来ます。

最大13ワット
(白熱球のご使用はお止め下さい。)

조립 안내 NORM 06 SMALL/한국어

내용물:

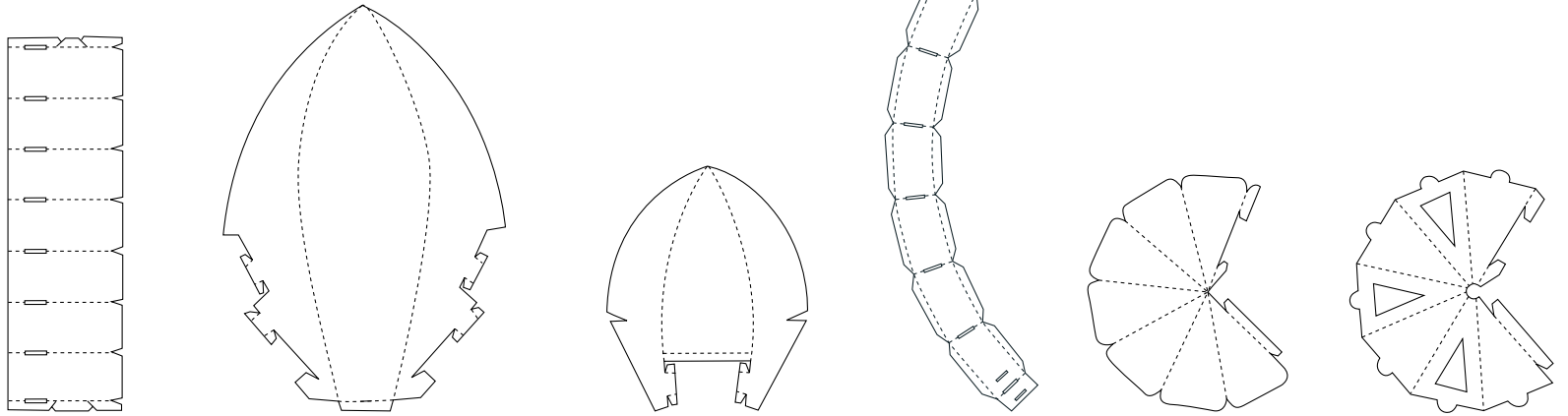

베이스
구성요소 1개

2번 전등갓
구성요소 7개

1번 전등갓
구성요소 7개

링 구성요소
S 1개

베이스 모듈 1개

매달기 모듈 1개

조립 안내:

1.

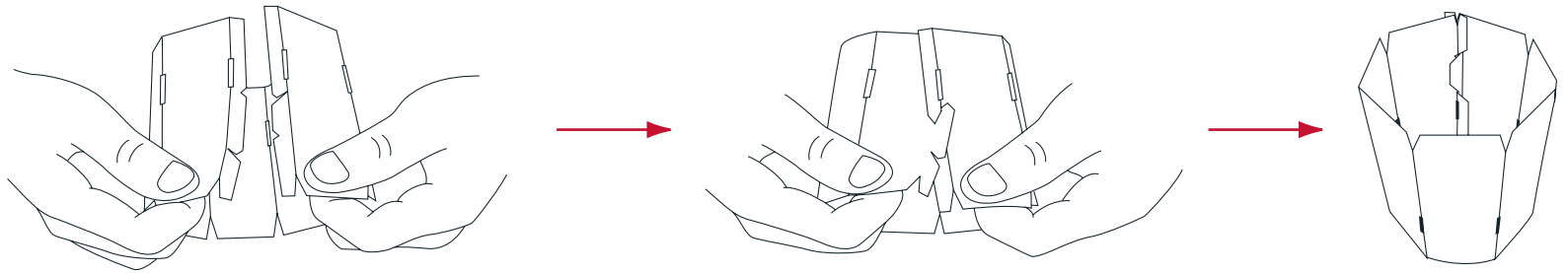

무광택면을 밖으로 7면 원통이 되도록
밀면을 서로 '맞물리게 한다'.

2.

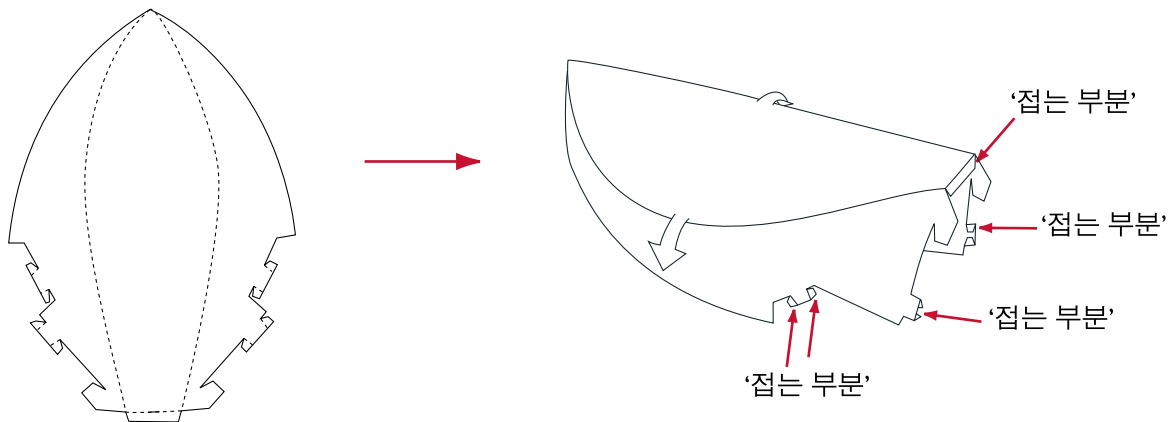

그림처럼 2번 전등갓 구성요소를 7개
접는다. 갓 구성요소의 곡선을 따라
조심스럽게 접는다.

무광택면을 밖으로 '접는 부분'을 접는다.

3.



베이스 구성요소에 있는 틈의 좁은 부분에 갓 구성요소를 끼운다.

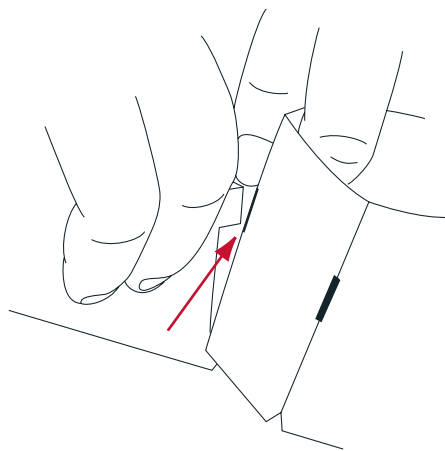

베이스 구성요소의 위쪽이 아래로 향하도록 뒤집고 구멍을 지나도록 '접는 부분'을 끼우고 뒷면에서 접어 모듈이 고정되도록 한다.

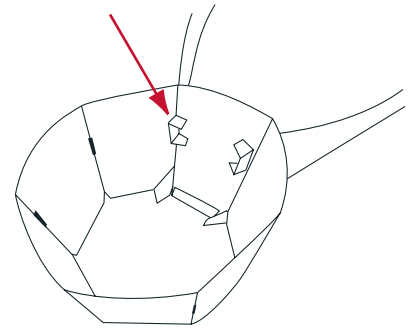

4.

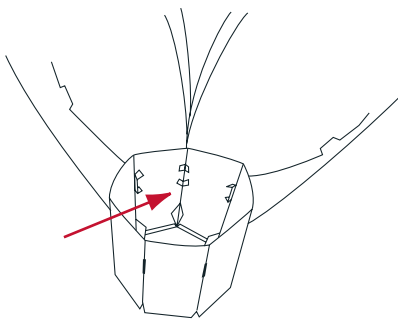

첫번째 갓 구성요소 옆 베이스에 다음 갓 구성요소를 끼우고 7개의 2번 전등갓 구성요소가 모두 올려질 때까지 반복한다. 베이스 안쪽에서 모듈을 고정하는 걸 잊지 않도록 한다.

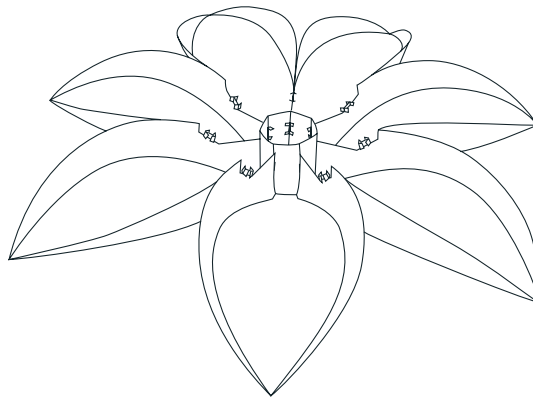

5.

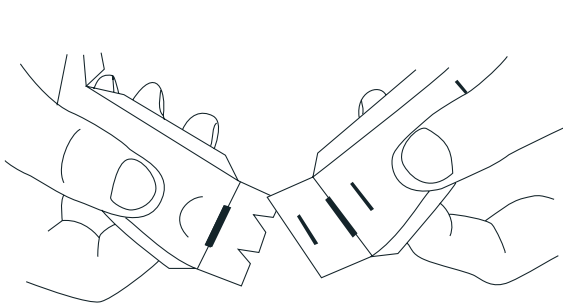

'S' 표시 링 구성요소를 집어 들고 강화 가장자리를 접는다. '접는 부분'을 활용하여 링 구성요소를 조립한다.

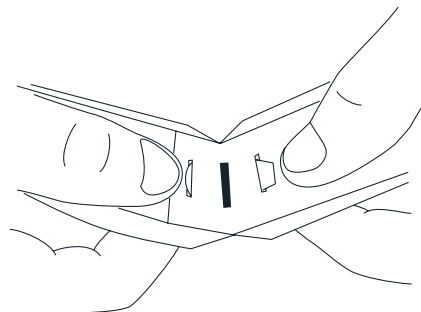

6.

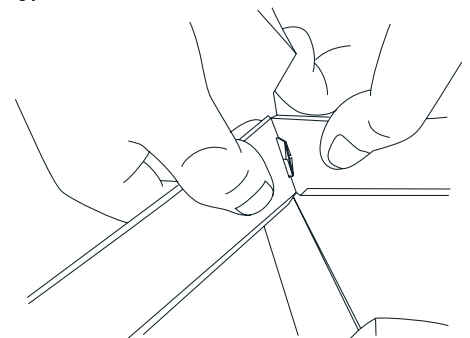

링 구성요소 'S' 를 전등갓 구성요소의 '접는 부분' 위에 올리고 '접는 부분' 을 펼쳐 고정한다.

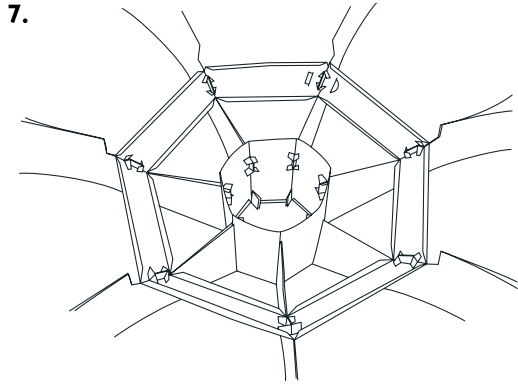

올바로 올려진 링 구성요소

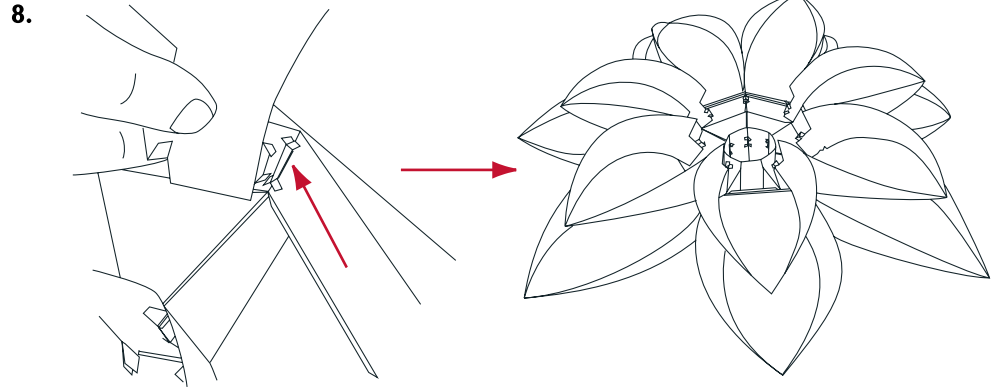

'1'번 전등갓 구성요소를 7개 접는다. 갓 구성요소의 곡선을 따라 조심스럽게 접는다. 다른 '접는 부분'들도 위치하고 있는 구멍을 지나도록 '접는 부분'을 밀어 링 구성요소 위에 첫번째 전등갓 구성요소를 올린다.

나머지 전등갓 구성요소도 비슷하게 모두 올린다. 뒷면에서 모듈을 고정하는 것을 잊지 않는다.

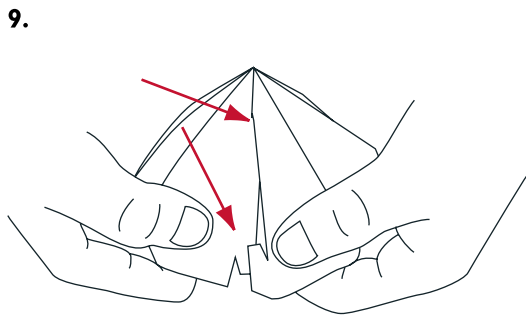

베이스 모듈을 구부려 조립한다. 접합 부분이 안쪽을 향하도록 한다.

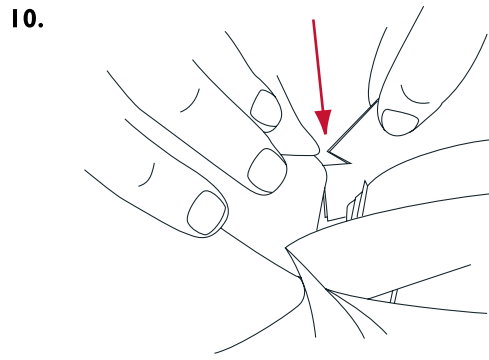

안쪽 전등갓 구성요소에 있는 홈에 베이스 모듈을 끼운다. (홈은 조그맣게 잘려져 있다.)

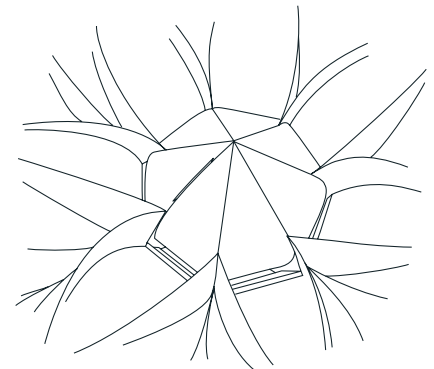

모두 조립된 베이스 모듈

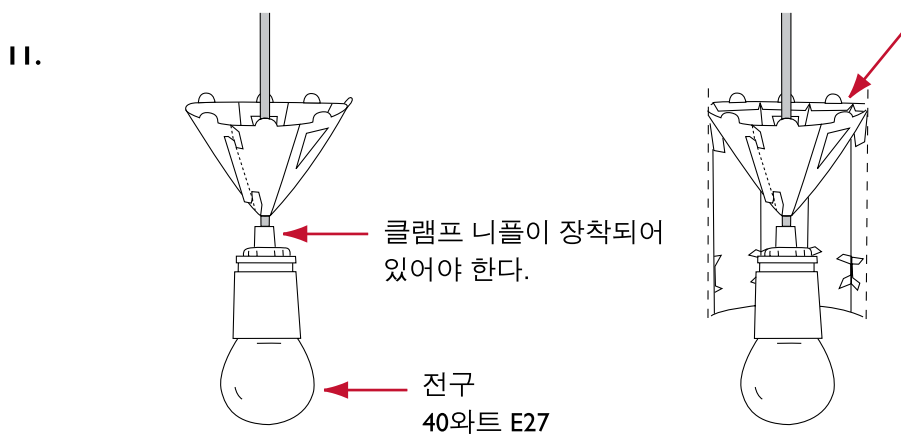

클램프 니플이 장착되어 있어야 한다.

전구
40와트 E27

여섯 방향에서 매달기 모듈을 구부리고 7면 원뿔을 이루도록 철사 둘레를 조립한다.

전등의 상단에 있는 틈이 위쪽을 향하도록 전등을 돌린다. 매달기 모듈을 틈 안으로 내리고 구멍을 지나도록 '접는 부분'을 민다. 강화 가장자리를 수평으로 접어 매달기 모듈을 고정한다.

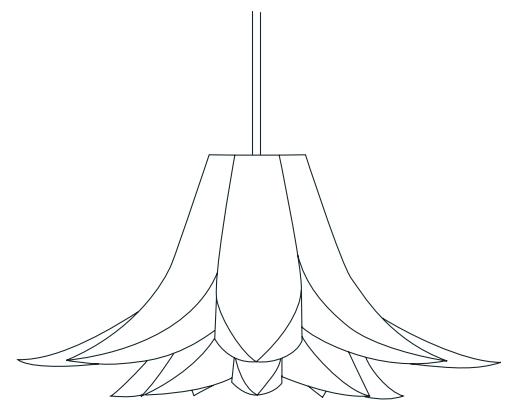

모두 조립되어 매달 수 있는 전등. 조명 기구를 떼지 않고도 전등을 매달 수 있다. 유연한 전등 베이스를 통해 전구를 쉽게 갈아낄 수 있다.

MAX 40 WATT

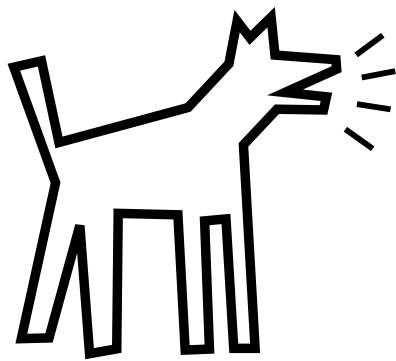

Normann Copenhagen, Østerbrogade 70, 2100 Copenhagen Ø, Denmark, Tel. +45 35 55 44 59, Fax +45 35 55 44 39

www.normann-copenhagen.com